

Learn
Phonics
Step by Step!



ENGLISH
CREATED RESOURCES



My Phonics Book

★ Part One ★

Short 'a' Sound

c ab



ab

c ab	l ab
d ab	n ab
g ab	t ab
j ab	s ab

Short 'a' Sound

d ad



ad

b ad	l ad
c ad	m ad
d ad	p ad
f ad	s ad

Short 'a' Sound

y am



am

c am	P am
d am	r am
h am	S am
j am	y am

Read!



Say!



Write!





© **Copyright English Created Resources. All rights reserved.**

This printable was created for you to use at home or with students in a classroom setting.

YOU MAY

- Download to your computer.
- Use this file for personal use at home.
- Use in your classroom.
- Print as many copies as you would like for personal and classroom use only.

YOU MAY NOT

- Extract or edit this printable.
- Share this PDF on Whatsapp, Facebook, Telegram, personal blog/website or by any other means without prior permission of the publisher.
- Upload the images onto your Facebook page or group without giving credit to **English Created Resources and sharing its website link.**
- Store or sell them on any website.
- Claim them as your own.
- **PRINT, SELL OR DISTRIBUTE THEM TO OTHERS.**

Clipart and elements found in this PDF are copyrighted and cannot be extracted or used outside of this file without permission or license.

For more FREE materials follow us on:

 <https://facebook.com/createdres>

 <https://t.me/freebooks4all>

 <https://twitter.com/createdres>

 <https://vk.com/createdres>

 <https://www.pinterest.com/createdres>

 <https://www.instagram.com/createdres>

 <https://www.threads.net/@createdres>

Thank you for your download!



Short 'a' Sound

y am

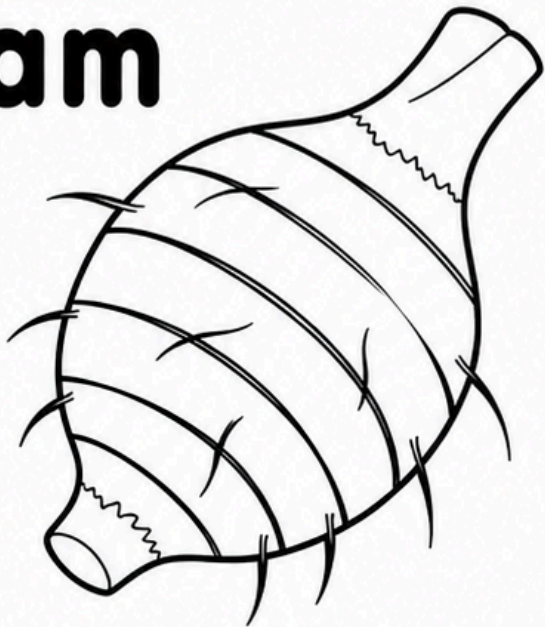

am

© 2026 English Created Resources

c am

p am

d am

r am

h am

s am

j am

y am



Short 'a' Sound

c ab



ab

© 2026 English Created Resources



c ab

l ab

d ab

n ab

g ab

t ab

j ab

s ab



Short 'a' Sound

dad



ad

© 2026 English Created Resources

bad

lad

cad

mad

dad

pad

fad

sad



Short 'a' Sound

bag



ag



bag

rag

gag

sag

hag

tag

nag

wag



Short 'a' Sound

cap



ap



cap

nap

gap

rap

lap

sap

map

tap



Short 'a' Sound

van

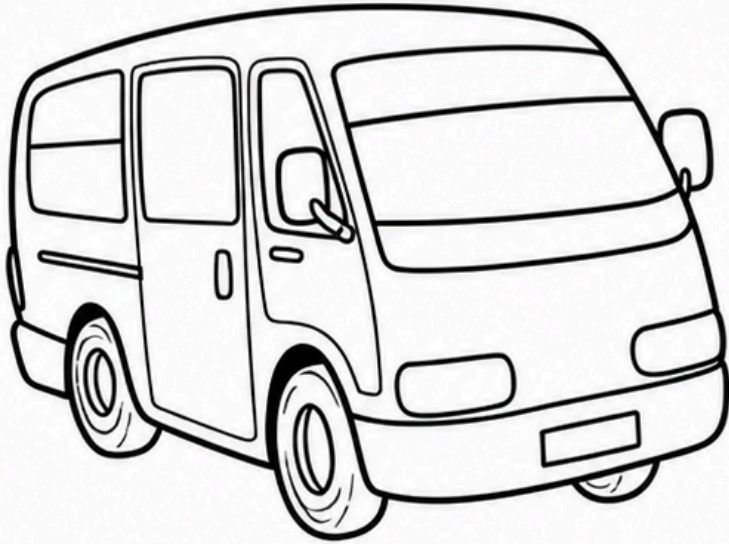

an

© 2026 English Created Resources

ban

pan

can

tan

fan

ran

man

van



Short 'a' Sound

c at



at

© 2026 English Created Resources

b at

m at

c at

p at

f at

r at

h at

s at



Short 'a' Sound

Sack

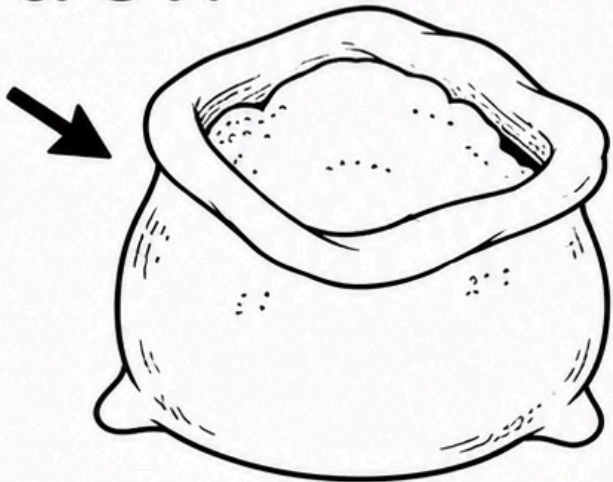

ack

b ack

p ack

h ack

r ack

J ack

s ack

l ack

t ack



Short 'a' Sound

r **a**ft

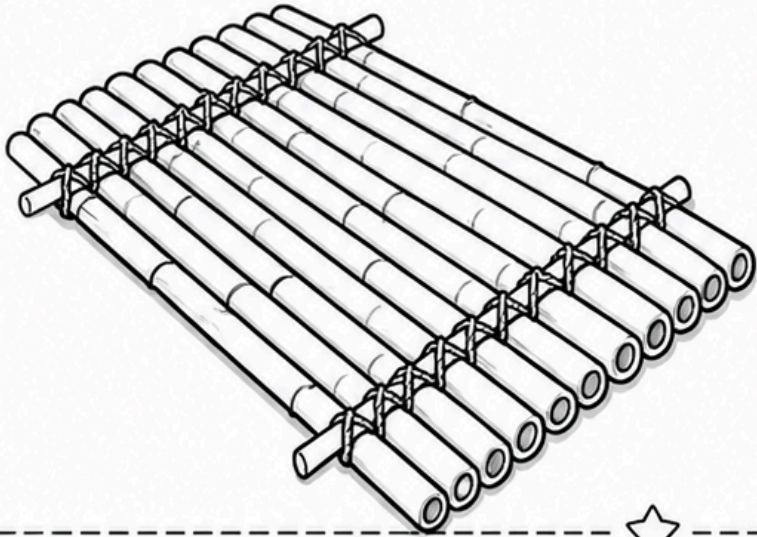

aft

© 2026 English Created Resources

a **a**ft

c **a**ft

d **a**ft

d **a**ft

r **a**ft

g **a**ft

w **a**ft

s **a**ft



Short 'a' Sound

h and



and

© 2026 English Created Resources

b and

bl and

h and

gl and

l and

st and

s and

br and



Short 'a' Sound

l **amp**



amp

© 2026 English Created Resources

c **amp**

v **amp**

d **amp**

ch **amp**

l **amp**

cl **amp**

r **amp**

st **amp**



Short 'a' Sound

plant



ant

ant

grant

pant

plant

rant

scant

chant

slant



Short 'a' Sound

glass

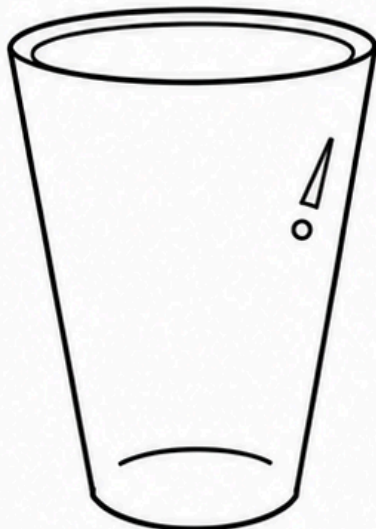

ass

© 2026 English Created Resources

bass

brass

lass

class

mass

glass

pass

grass



Short 'a' Sound

b ang



ang

b ang

r ang

f ang

s ang

g ang

s ang

h ang

spr ang



Short 'a' Sound

Cash



ash

© 2026 English Created Resources

bash

hash

cash

lash

dash

mash

gash

rash



Short 'a' Sound

fast



ast



bast

mast

cast

past

fast

vast

last

blast



Broad 'a' Sound

star



ar



bar

mar

car

par

far

tar

jar

star



Broad 'a' Sound

shark

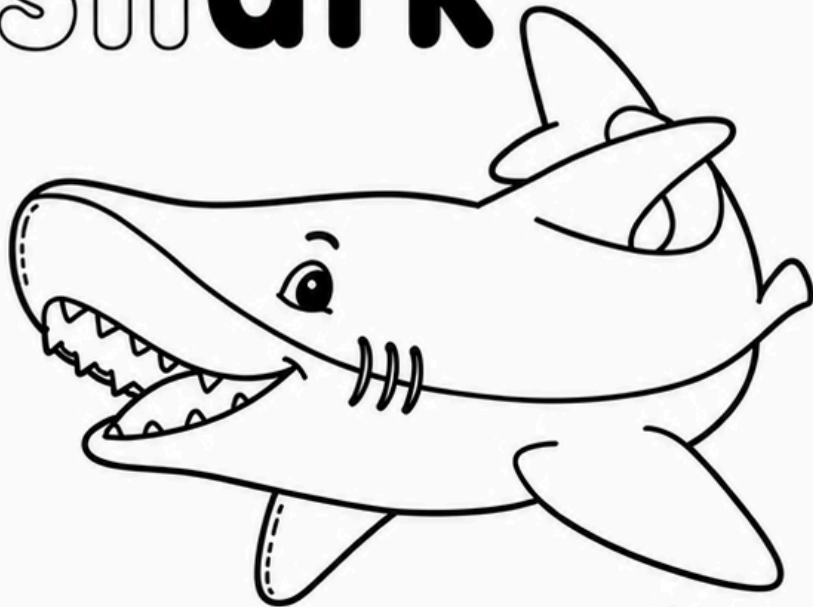

ark

© 2026 English Created Resources

bark

mark

dark

shark

lark

spark

park

stark



Broad 'a' Sound

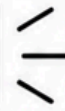

cart

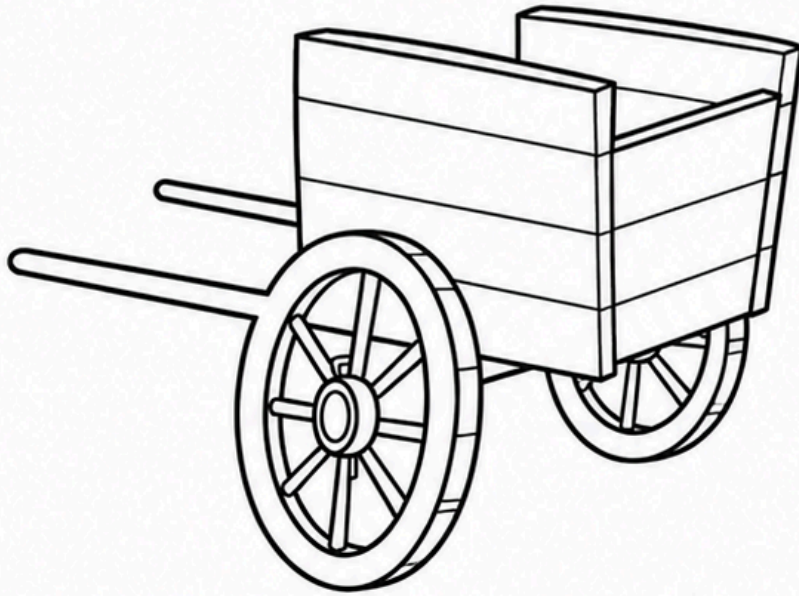

art



cart

part

dart

tart

hart

wart

mart

start



English Created Resources prides itself on providing everything a learner needs to improve the level of English.

Such materials are provided for free download to be available for learners around the world. You can find English ESL worksheets for home learning, online practice, distance learning and for English classes.

Our Website helps you to give your child a boost using our free printables. You will be able to help your child with his grammar skills with our printables that focus on using punctuation, reading and writing. Such worksheets are a useful learning tool for kids who are trying to read, write or want to practice their English language skills at home.

Designed by English Created Resources



Beni Suef, Egypt



copyrightsupport@createdres.com



[createdres.com](https://www.createdres.com)

www.nortechplus.com

For more FREE materials follow us on:



<https://facebook.com/createdres>



<https://twitter.com/createdres>



<https://www.pinterest.com/createdres>



<https://t.me/freebooks4all>



<https://www.instagram.com/createdres>



<https://vk.com/createdres>

