

















Valentine Numbers 1-20

Math Cube Towers

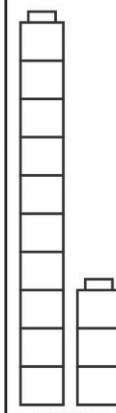
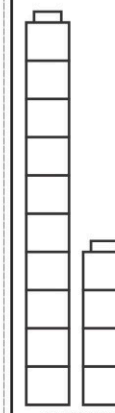
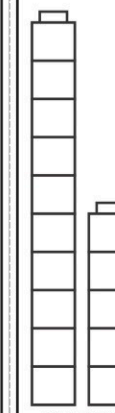
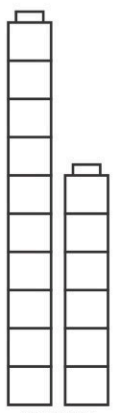
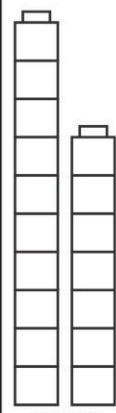
1 	2 	3 	4 	5 	6 	7 	8 	9 	10 
									

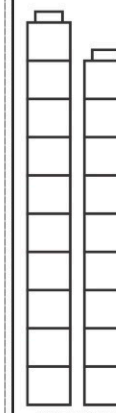
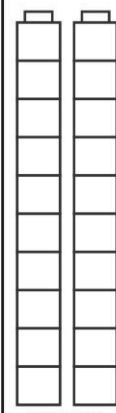
Number Tower 1-10
Use link cubes to build a tower that matches the amount on each box. Place the towers on the matching numbers.

Number Tower 1-10
Use link cubes to build a tower that matches the amount on each box. Place the towers on the matching numbers.

Number Tower 1-10
Use link cubes to build a tower that matches the amount on each box. Place the towers on the matching numbers.

Number Tower 11-20
Use link cubes to build a tower that matches the amount on each box. Place the towers on the matching numbers.

Number Tower 11-20
Use link cubes to build a tower that matches the amount on each box. Place the towers on the matching numbers.

Number Tower 11-20
Use link cubes to build a tower that matches the amount on each box. Place the towers on the matching numbers.



© **Copyright English Created Resources. All rights reserved.**

This printable was created for you to use at home or with students in a classroom setting.

YOU MAY

- Download to your computer.
- Use this file for personal use at home.
- Use in your classroom.
- Print as many copies as you would like for personal and classroom use only.

YOU MAY NOT

- Extract or edit this printable.
- Share this PDF on Whatsapp, Facebook, Telegram, personal blog/website or by any other means without prior permission of the publisher.
- Upload the images onto your Facebook page or group without giving credit to **English Created Resources and sharing its website link.**
- Store or sell them on any website.
- Claim them as your own.
- **PRINT, SELL OR DISTRIBUTE THEM TO OTHERS.**

Clipart and elements found in this PDF are copyrighted and cannot be extracted or used outside of this file without permission or license.

For more FREE materials follow us on:

 <https://facebook.com/createdres>

 <https://t.me/freebooks4all>

 <https://twitter.com/createdres>

 <https://vk.com/createdres>

 <https://www.pinterest.com/createdres>

 <https://www.instagram.com/createdres>

 <https://www.threads.net/@createdres>

Thank you for your download!

Thank you to the amazing Graphic Artist that helped us to create these materials.



Follow Activity Boosters on
Teachers Pay Teachers and Facebook
for more great materials :)

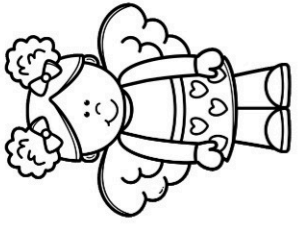

5

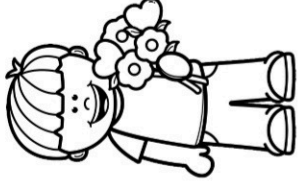

4

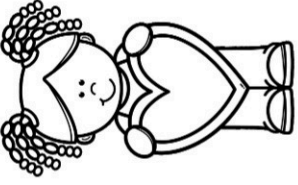

3



2

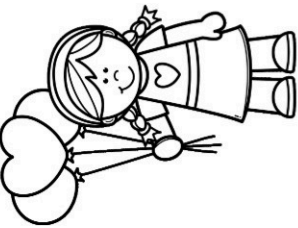

1



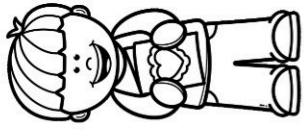

10

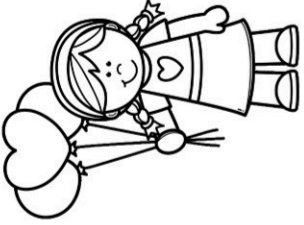

9

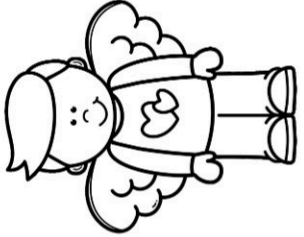

8

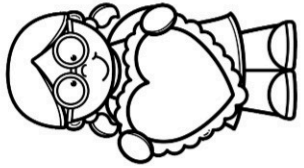

7

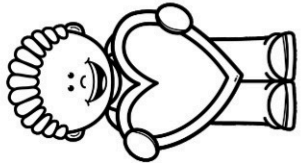

6



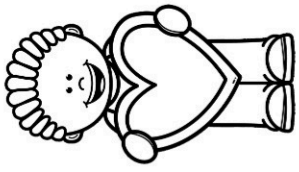

15

--	--	--	--	--	--	--	--	--	--

--	--	--	--	--

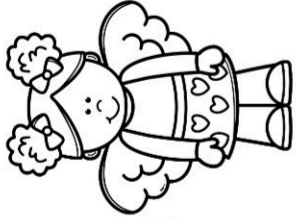

14

--	--	--	--	--	--	--	--	--	--

--	--	--	--

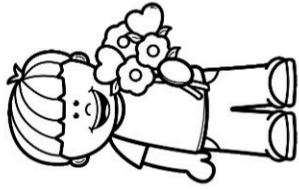

13

--	--	--	--	--	--	--	--	--	--

--	--	--

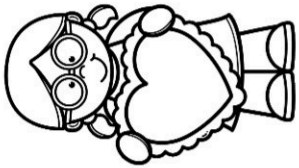

12

--	--	--	--	--	--	--	--	--	--

--	--

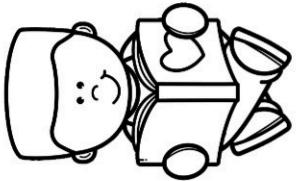

11

--	--	--	--	--	--	--	--	--	--

--

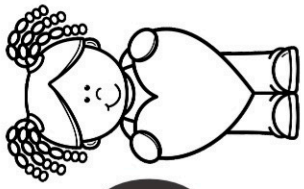

20

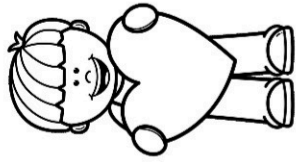

19

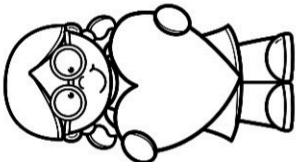

18

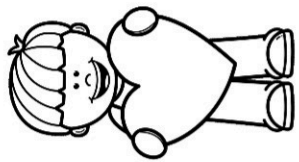

17

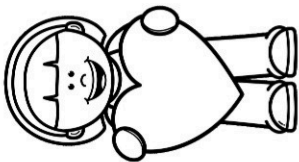

16

Number Tower 1-10

Use link cubes to build a tower that matches the amount on each box.
Place the towers on the matching numbers.

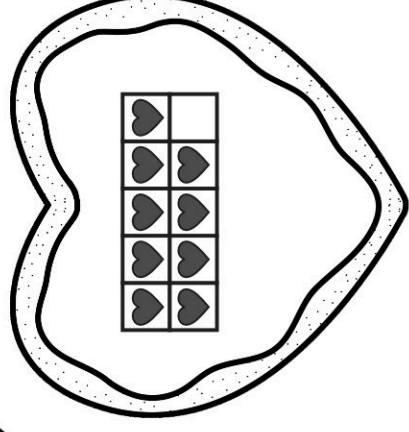
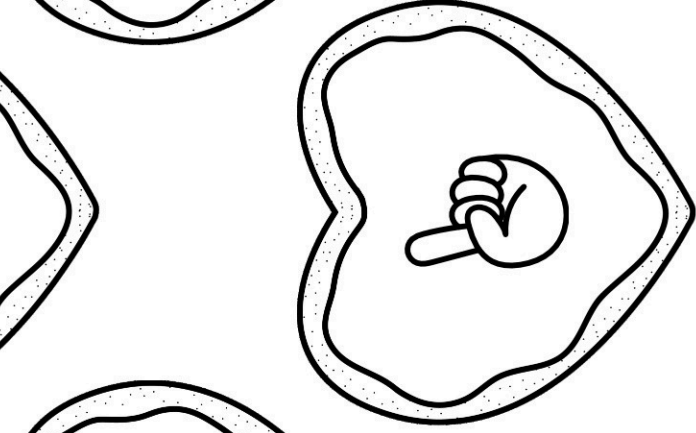
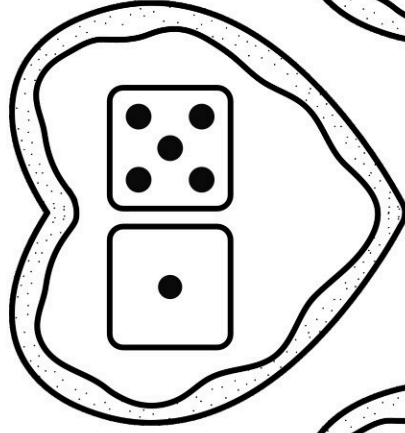
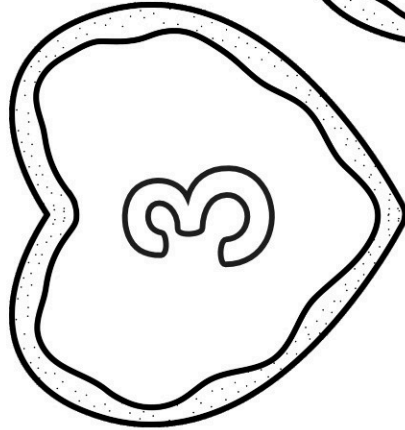
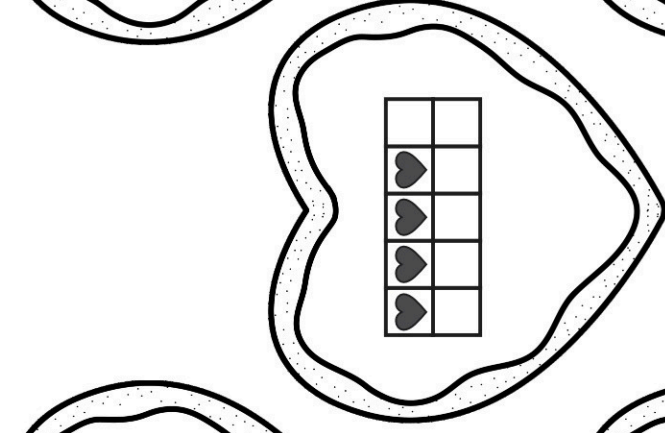
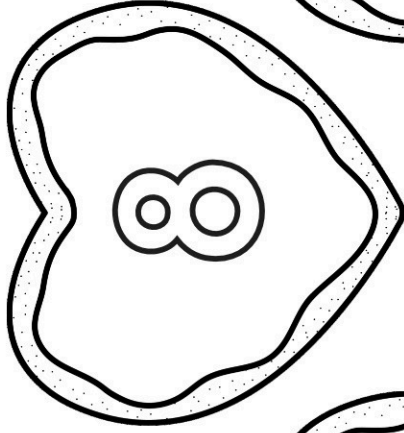
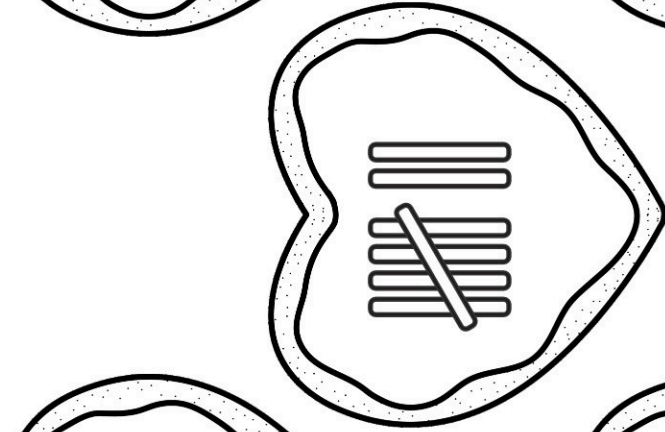
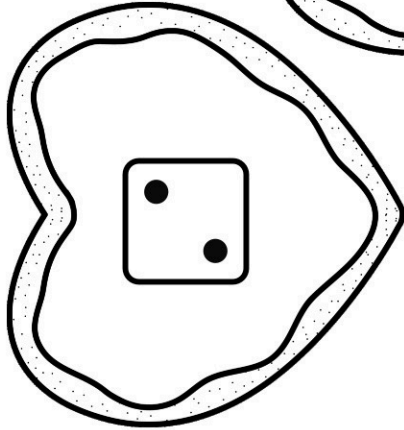

Number Tower 1-10

Use link cubes to build a tower that matches the amount on each box.
Place the towers on the matching numbers.

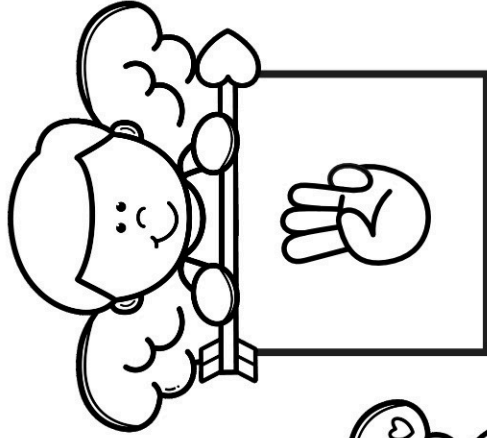
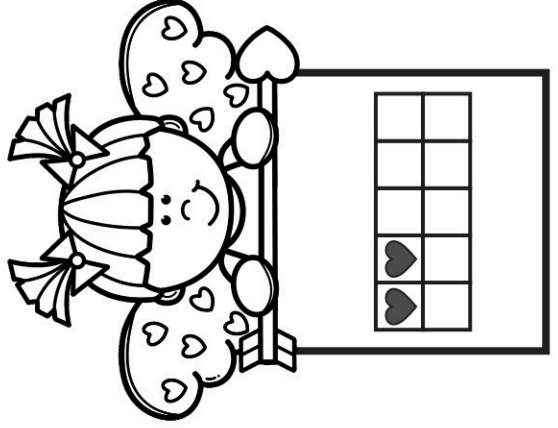
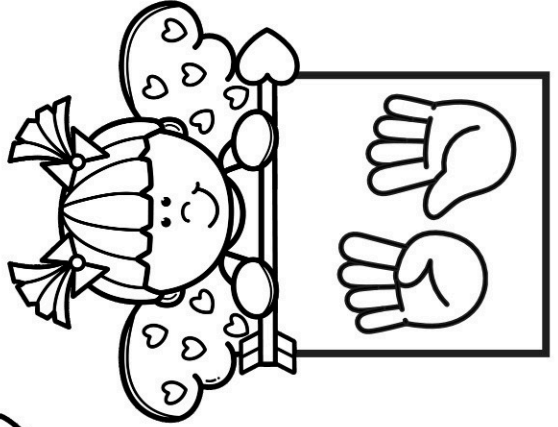
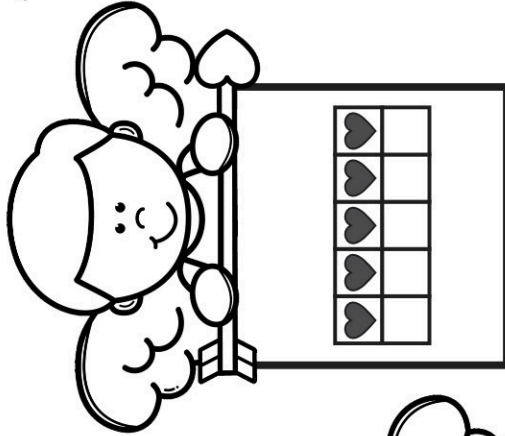
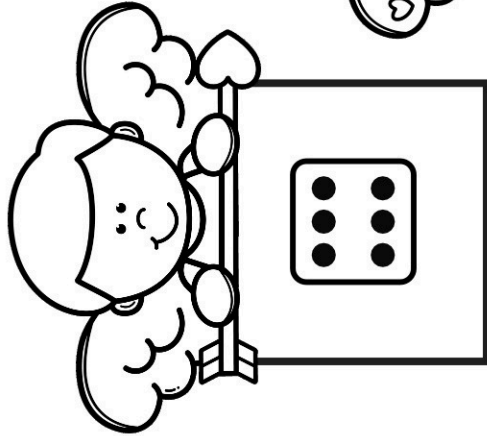
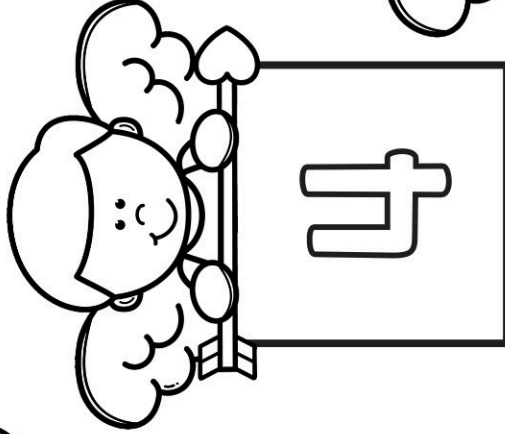
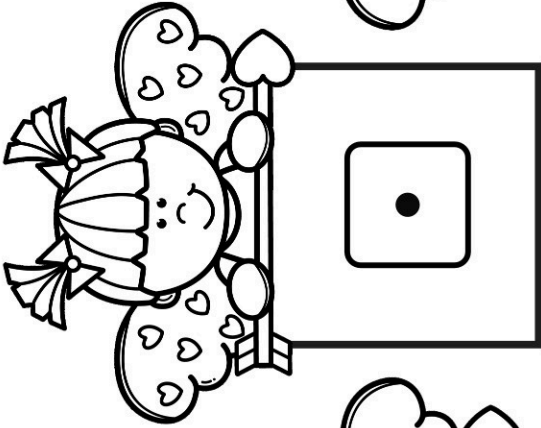
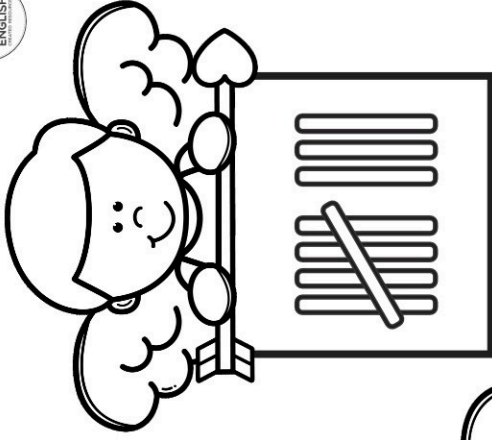
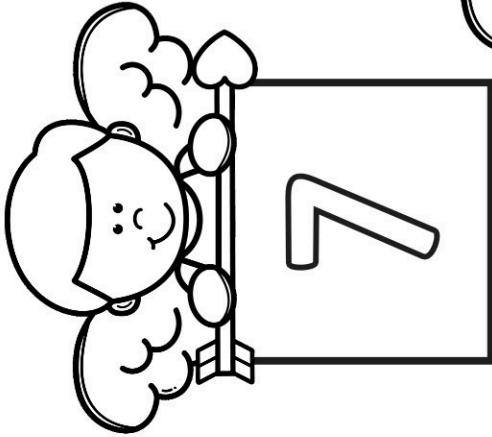

Number Tower 1-10

Use link cubes to build a tower that matches the amount on each box.
Place the towers on the matching numbers.

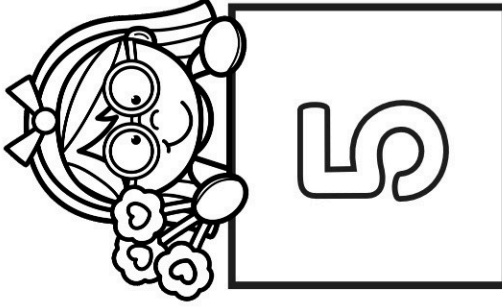
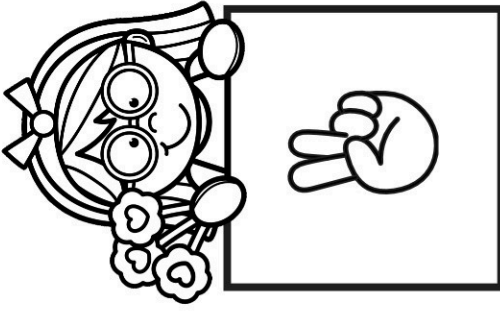
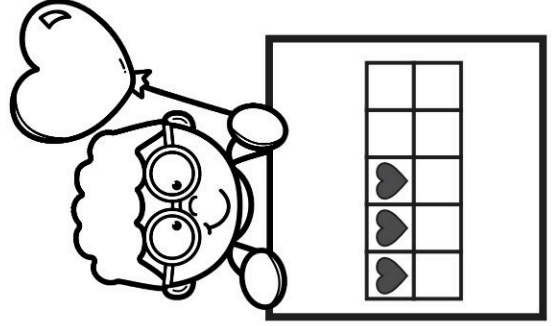
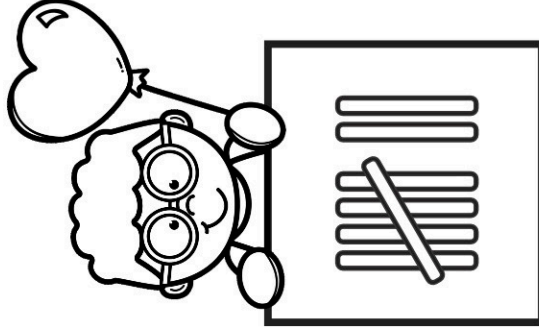
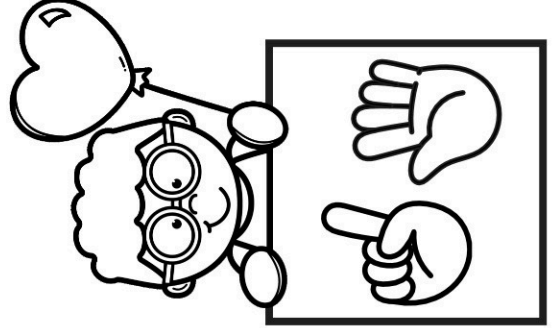
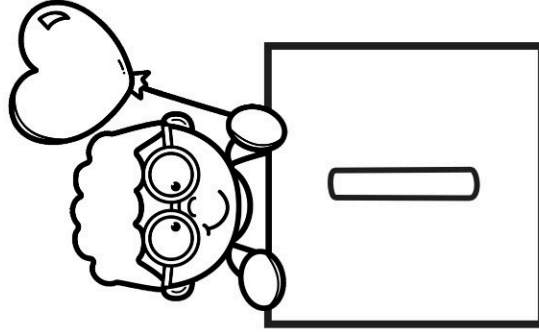
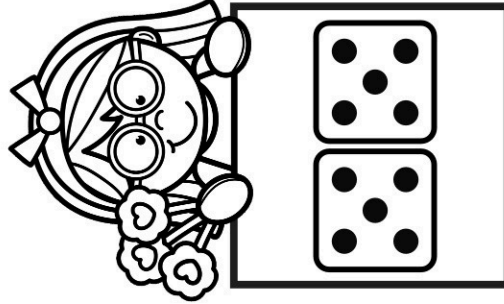
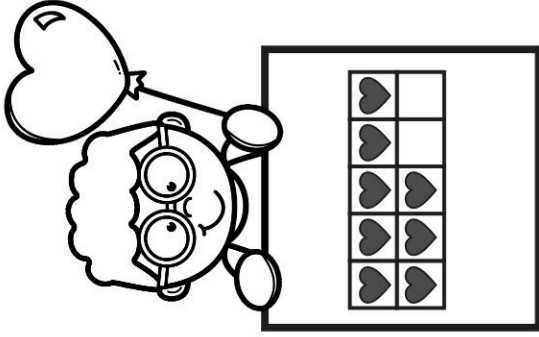
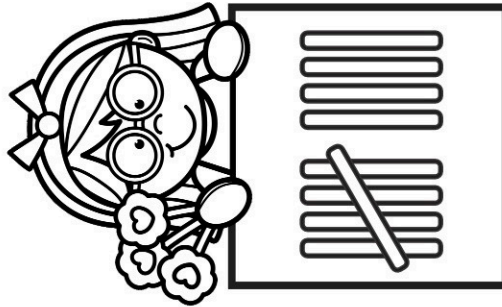
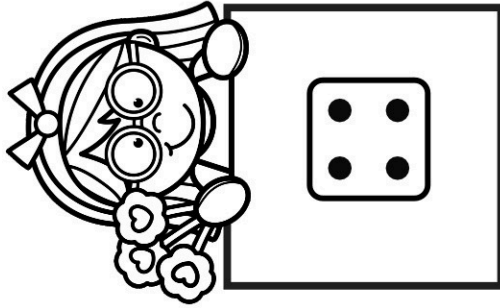

Number Tower 1-10

Use link cubes to build a tower that matches the amount on each box.
Place the towers on the matching numbers.

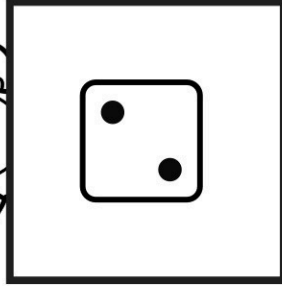
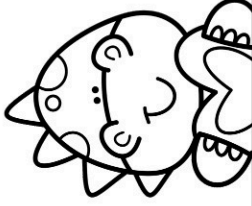
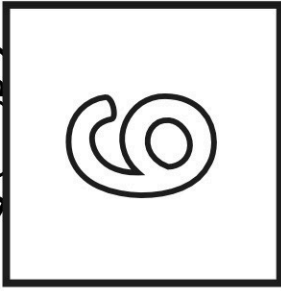
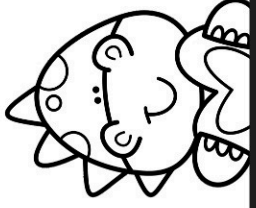
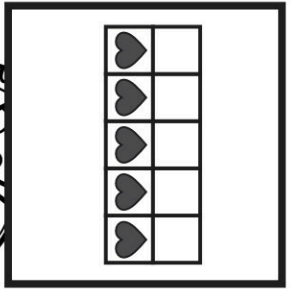
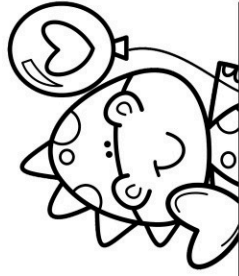
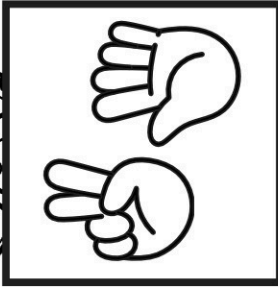
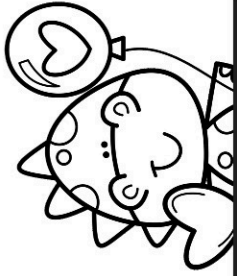
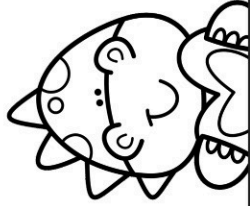
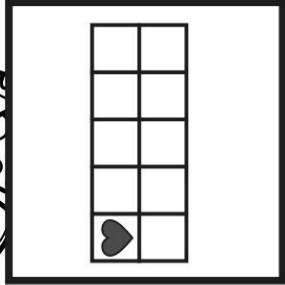
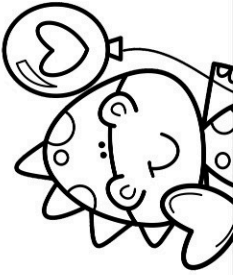
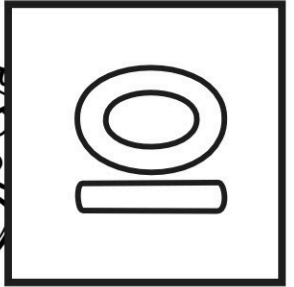
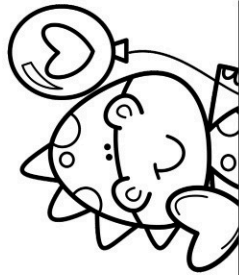
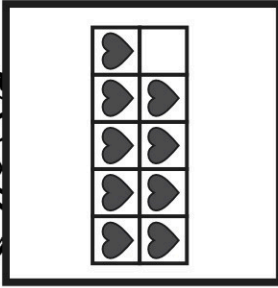
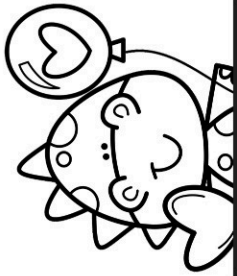
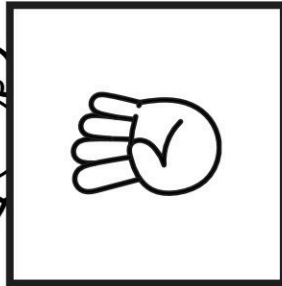
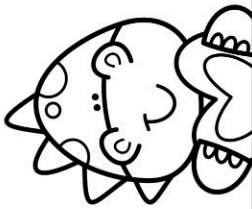
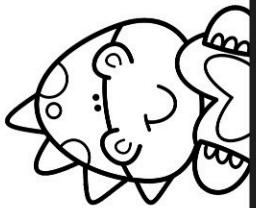

Number Tower 1-10

Use link cubes to build a tower that matches the amount on each box.
Place the towers on the matching numbers.

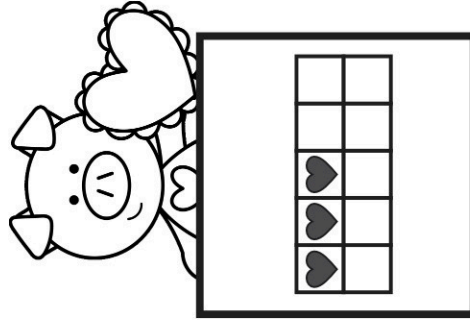
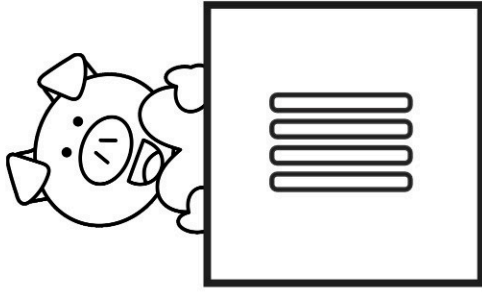
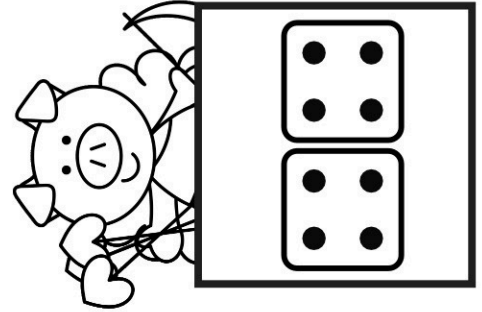
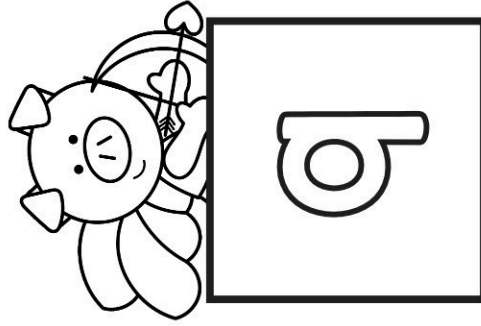
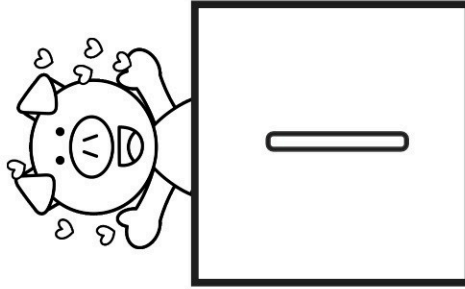
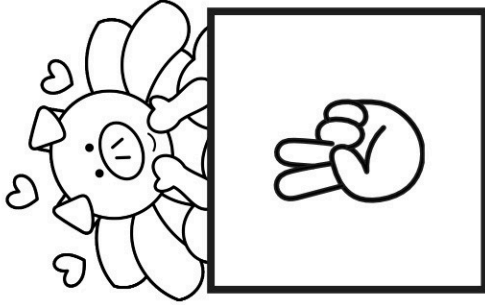
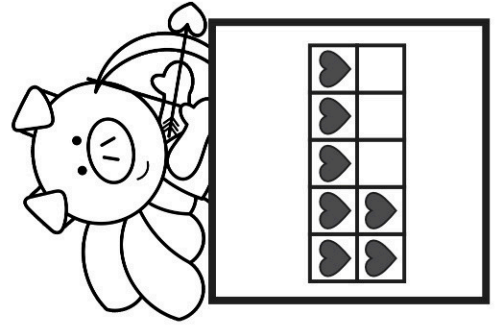
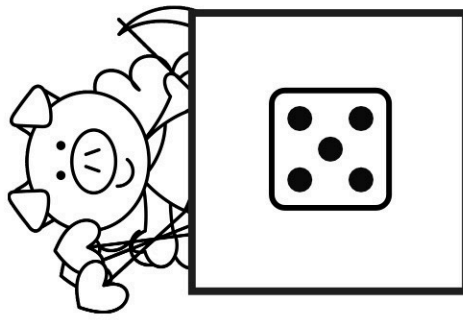
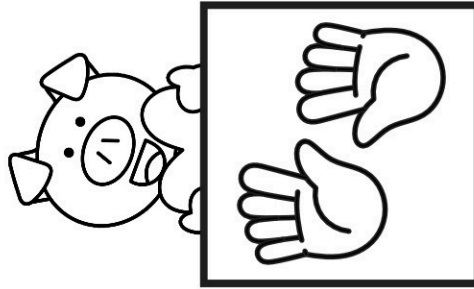
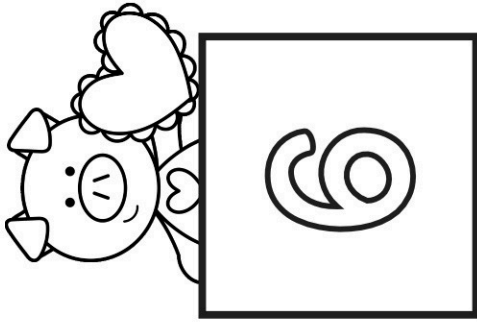

Number Tower 1-10

Use link cubes to build a tower that matches the amount on each box.
Place the towers on the matching numbers.

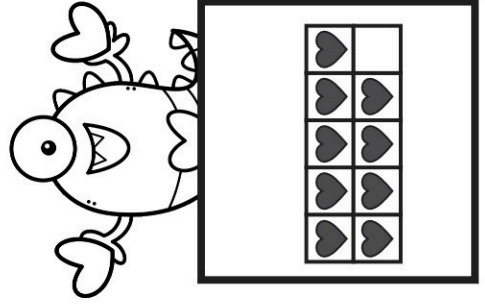
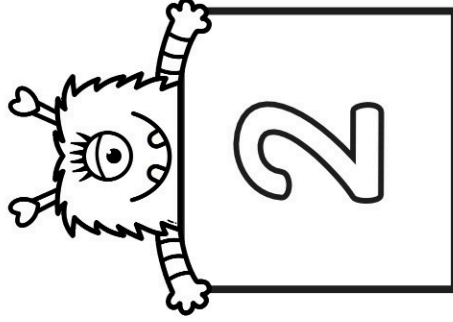
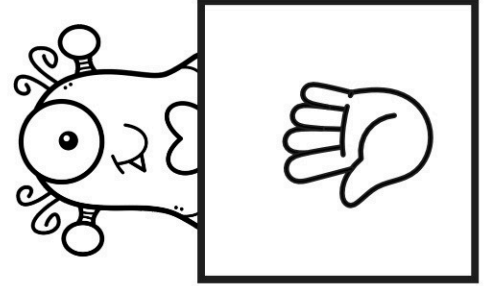
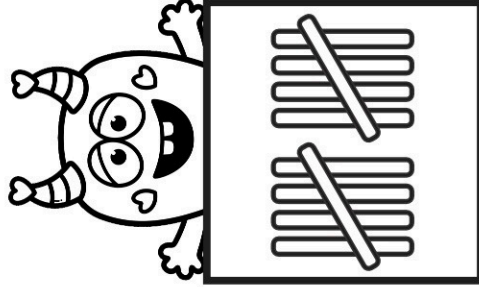
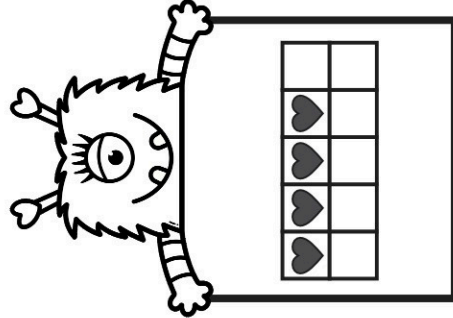
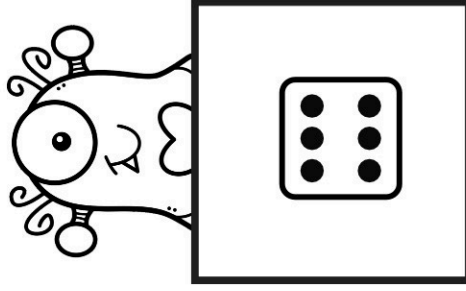
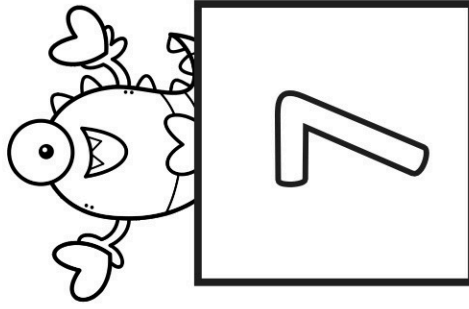
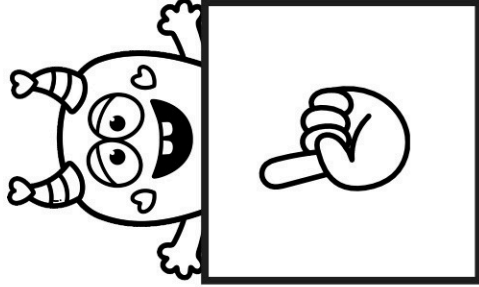
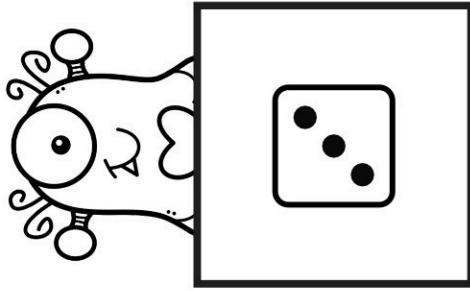

Number Tower II-20

Use link cubes to build a tower that matches the amount on each box.
Place the towers on the matching numbers.

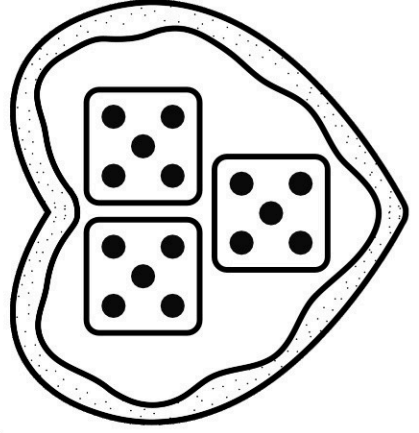
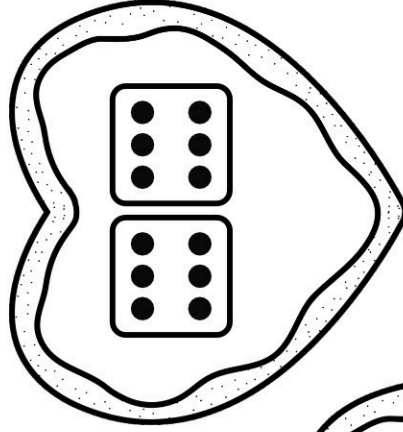
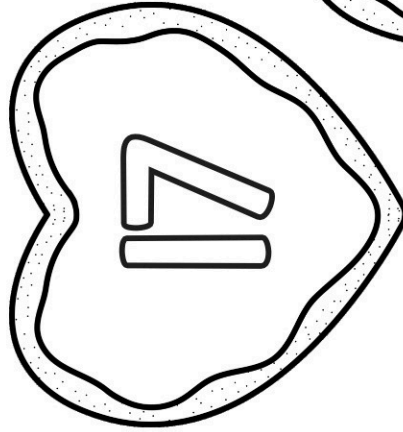
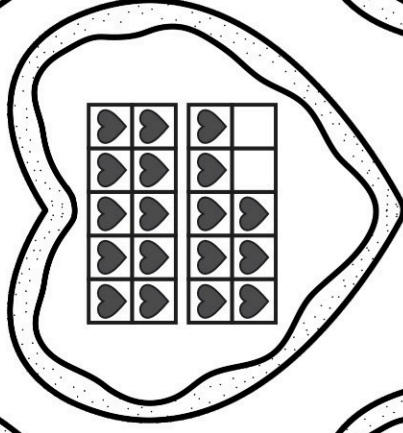
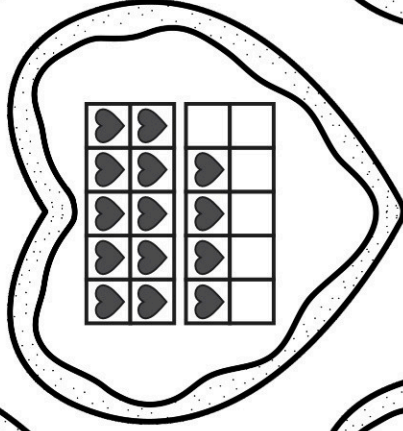
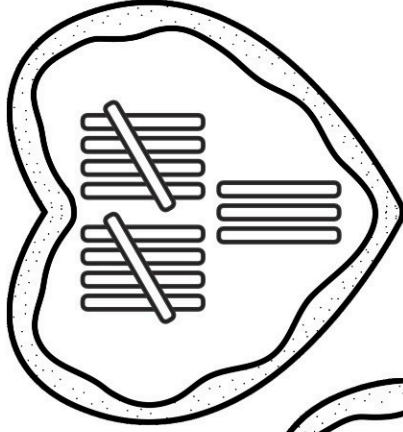
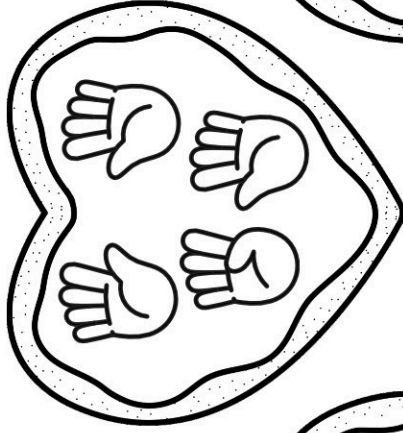
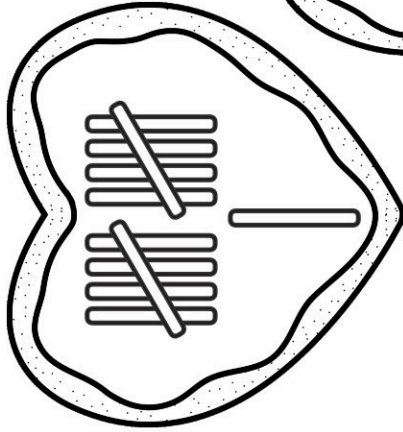

Number Tower II-20

Use link cubes to build a tower that matches the amount on each box.
Place the towers on the matching numbers.

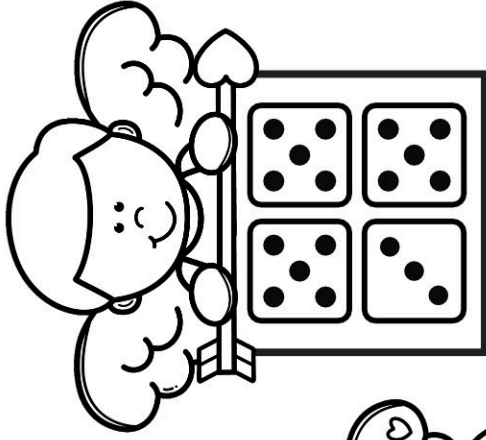
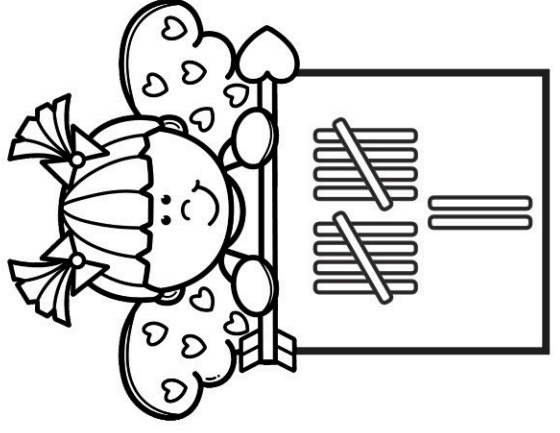
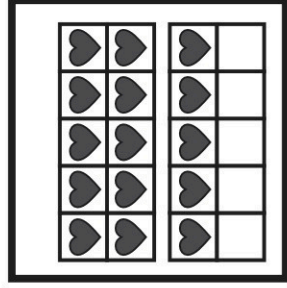
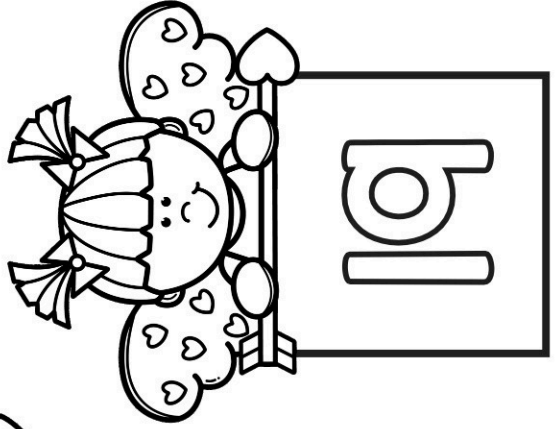
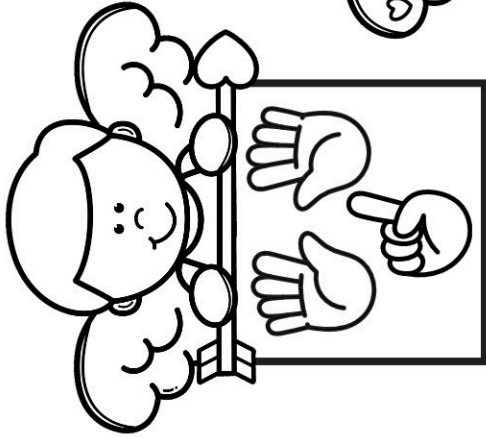
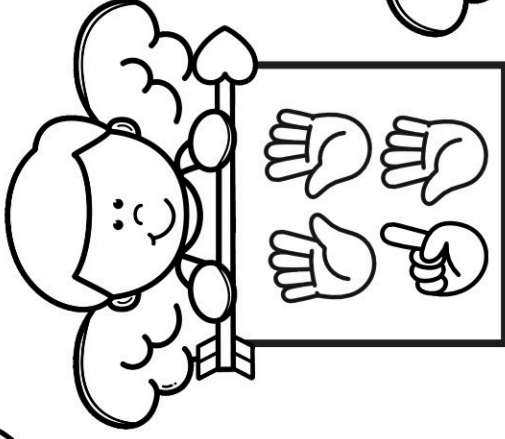
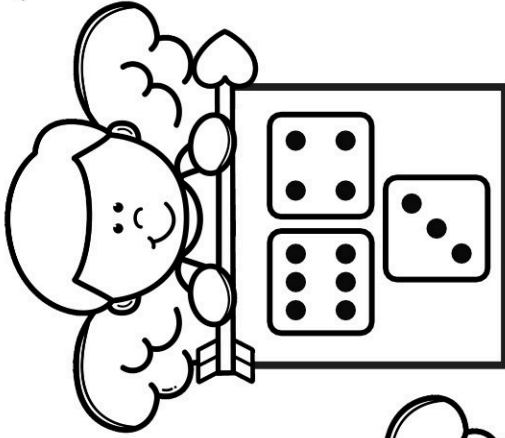
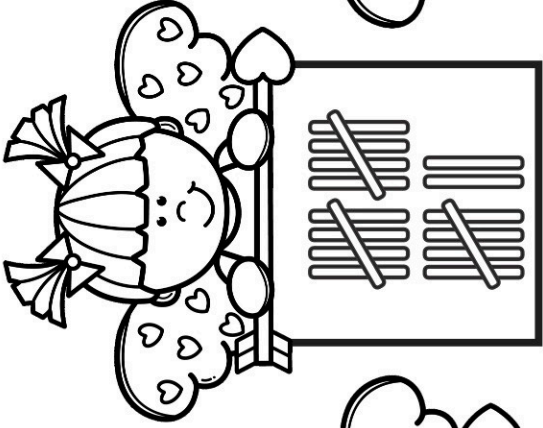
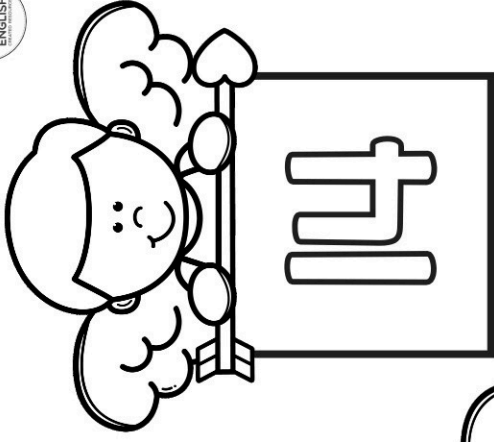
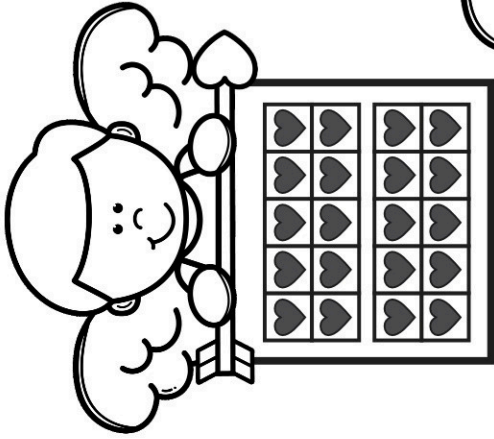

Number Tower II-20

Use link cubes to build a tower that matches the amount on each box.
Place the towers on the matching numbers.

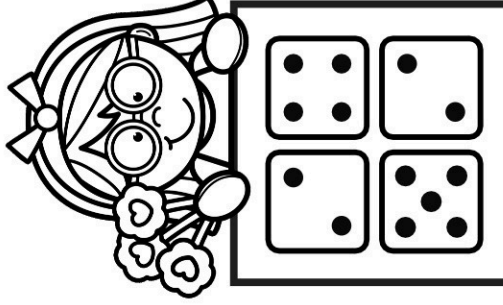
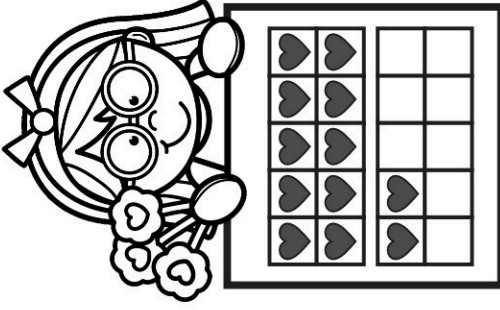
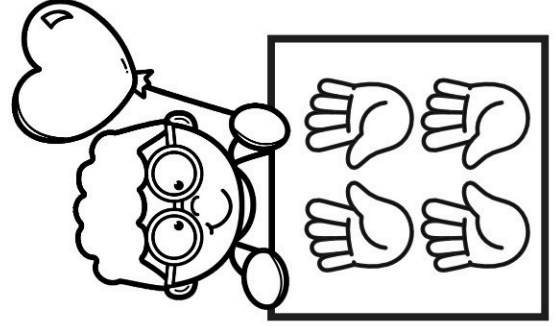
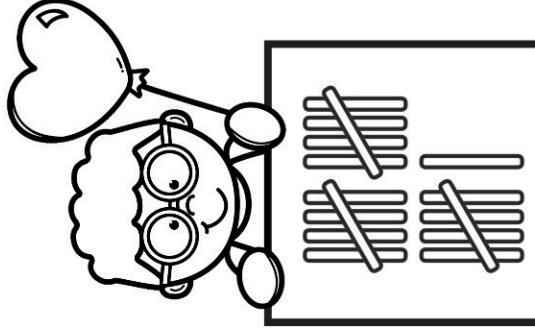
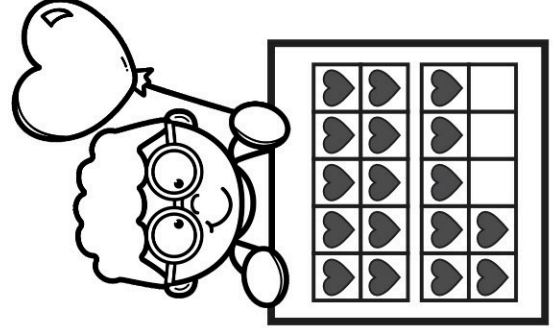
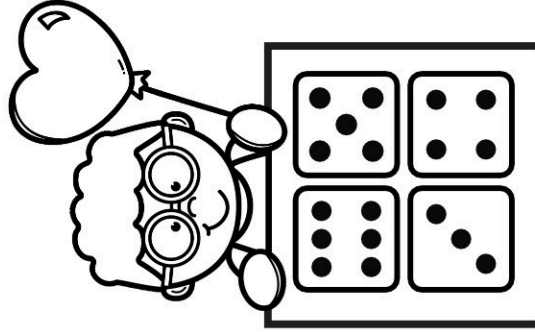
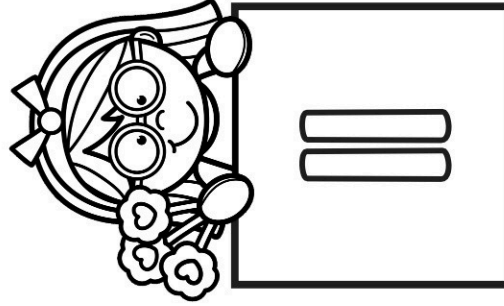
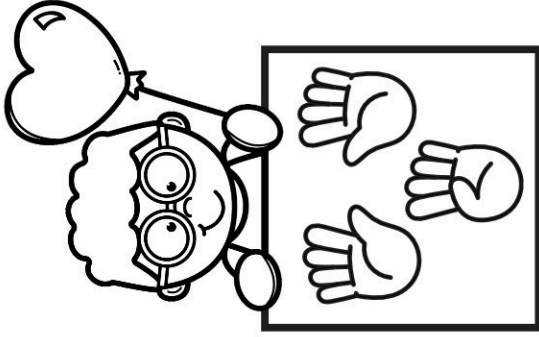
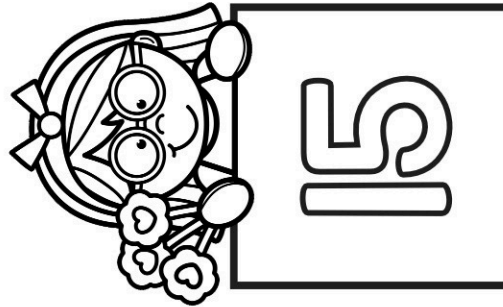
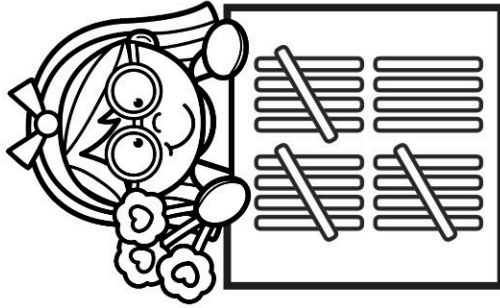

Number Tower II-20

Use link cubes to build a tower that matches the amount on each box.
Place the towers on the matching numbers.

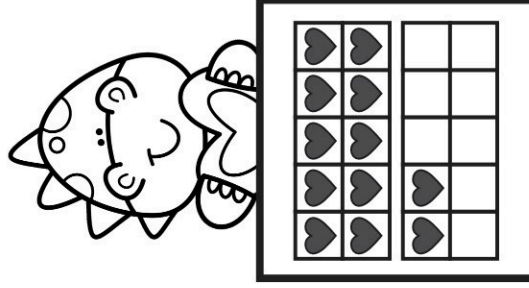
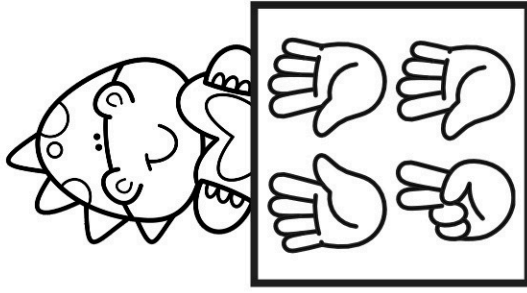
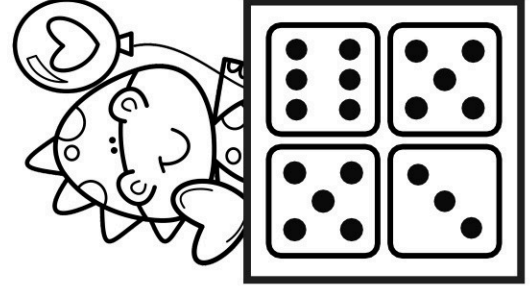
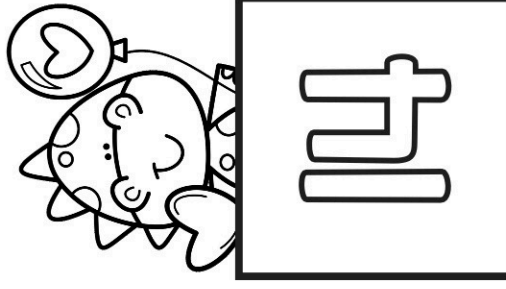
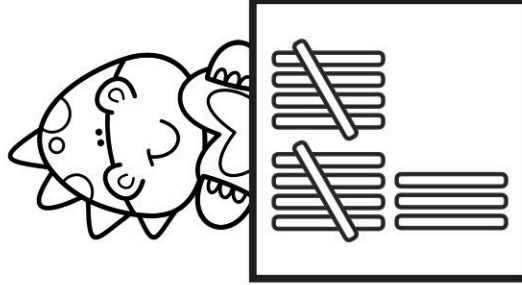
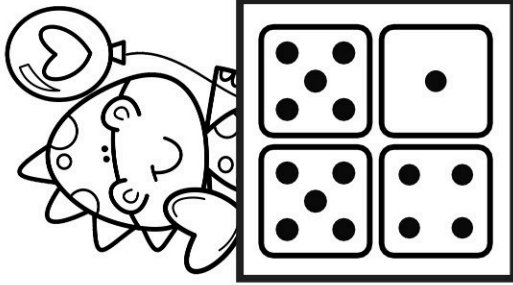
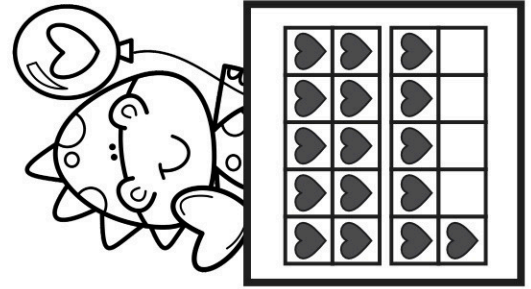
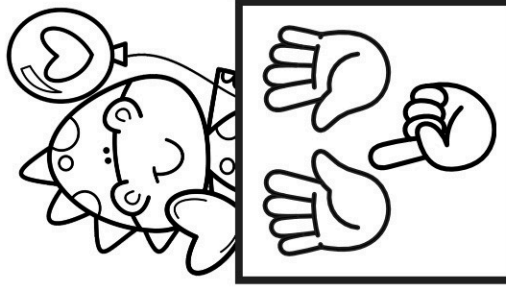
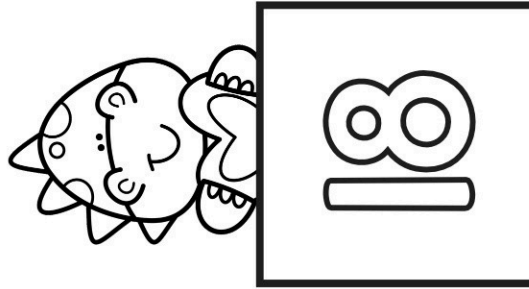
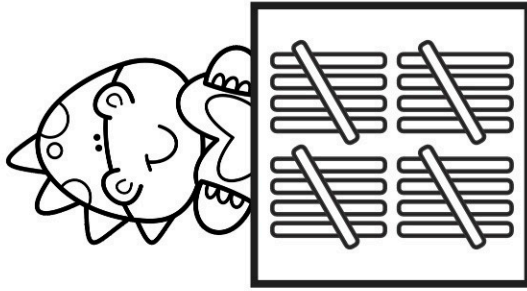

Number Tower II-20

Use link cubes to build a tower that matches the amount on each box.
Place the towers on the matching numbers.

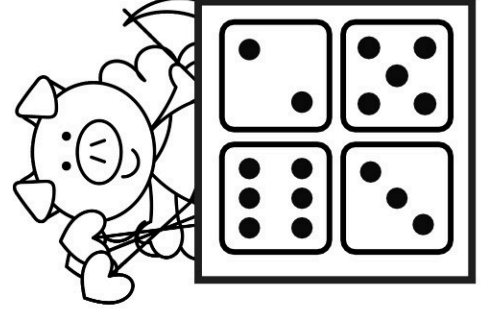
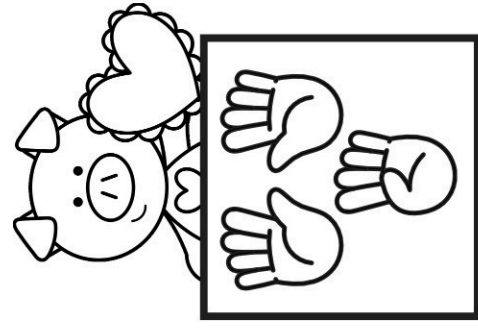
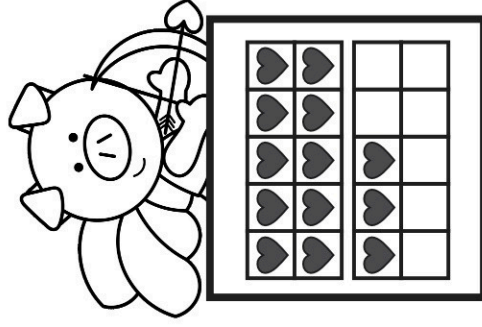
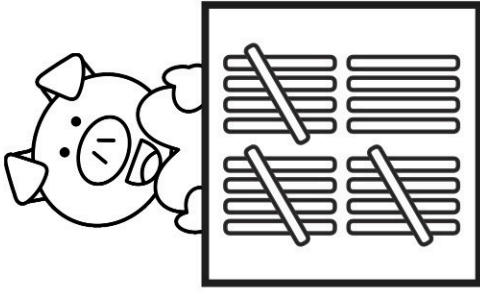
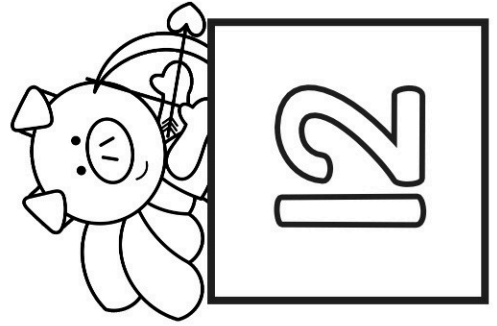
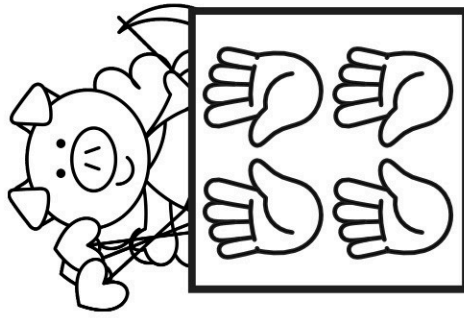
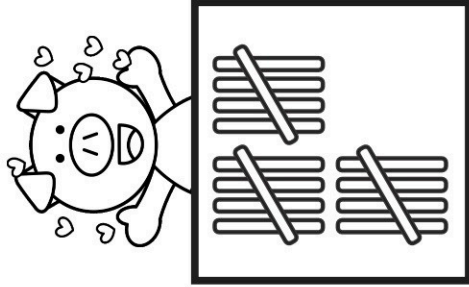
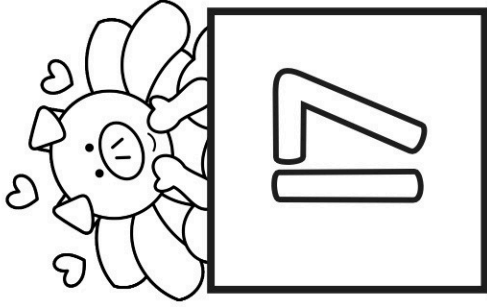
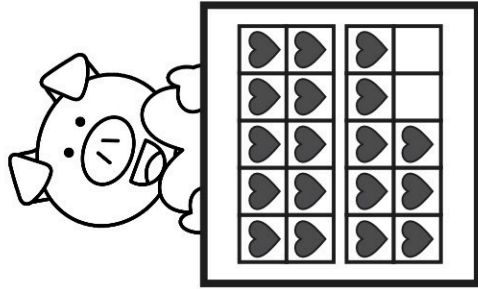
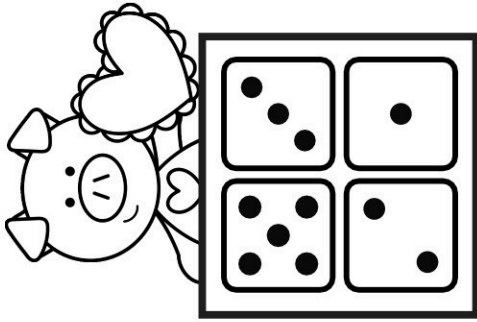

Number Tower II-20

Use link cubes to build a tower that matches the amount on each box.
Place the towers on the matching numbers.

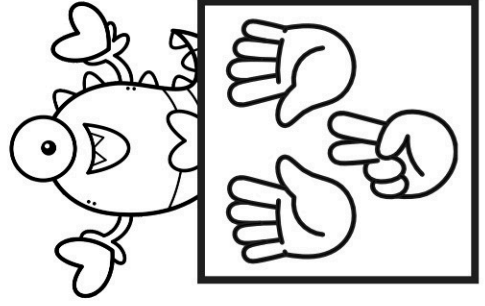
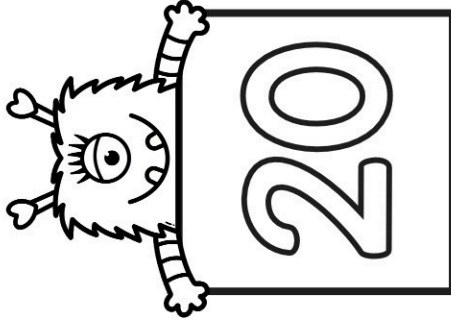
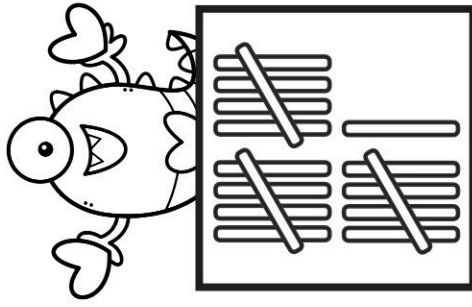
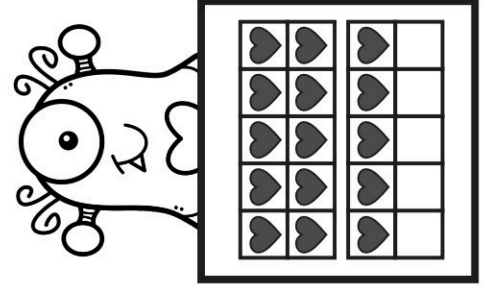
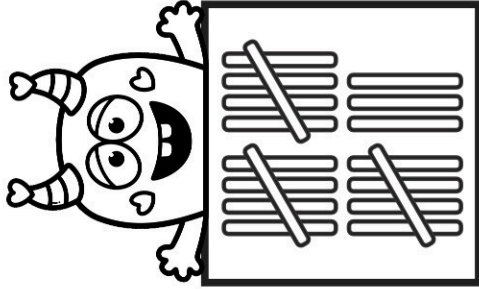
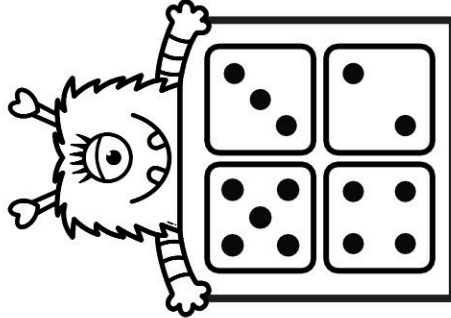
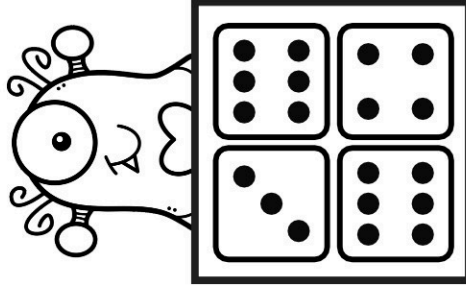
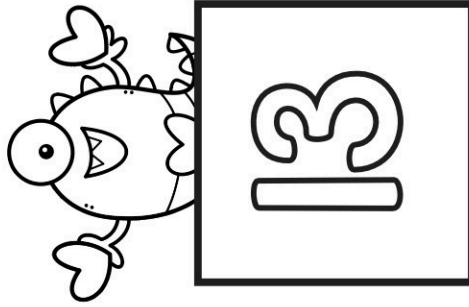
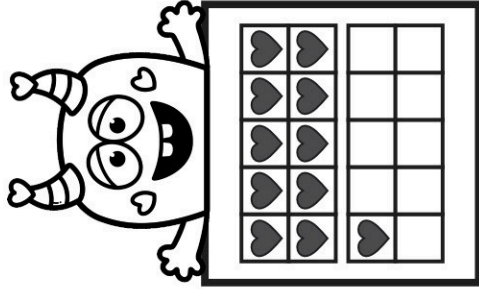
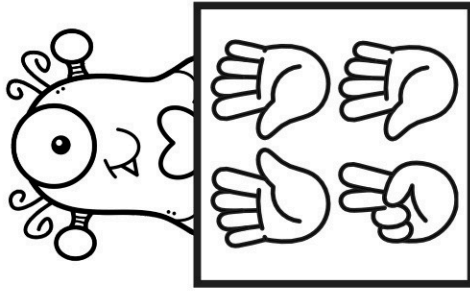



English Created Resources prides itself on providing everything a learner needs to improve the level of English.

Such materials are provided for free download to be available for learners around the world. You can find English ESL worksheets for home learning, online practice, distance learning and for English classes.

Our Website helps you to give your child a boost using our free printables. You will be able to help your child with his grammar skills with our printables that focus on using punctuation, reading and writing. Such worksheets are a useful learning tool for kids who are trying to read, write or want to practice their English language skills at home.

Designed by English Created Resources



Beni Suef, Egypt



copyrightsupport@createdres.com



[createdres.com](https://www.createdres.com)

www.nortechplus.com

For more FREE materials follow us on:



<https://facebook.com/createdres>



<https://twitter.com/createdres>



<https://www.pinterest.com/createdres>



<https://t.me/freebooks4all>



<https://www.instagram.com/createdres>



<https://vk.com/createdres>

