











**FREE**

**KINDERGARTEN / GRADE 1**

**Freebie**

© Copyright English Created Resources 2021

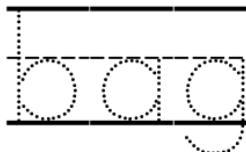
# Hidden Pictures

				
How many do you see?				
Write the word				



© Copyright English Created Resources. All rights reserved.

This printable was created for you to use at home or with students in a classroom setting.

**YOU MAY:**

- Download to your computer.
- Use this file for personal use at home.
- Use in your classroom.
- Print as many copies as you would like for personal use only.

**YOU MAY NOT**

- Extract or edit this printable.
- Share this PDF on Whatsapp, Facebook, Telegram, personal blog/website or by any other means without prior permission of the publisher.
- Upload the images onto your Facebook page or group without giving credit to **English Created Resources and sharing its website link.**
- Store or sell them on any website.
- Claim them as your own.
- **PRINT AND SELL OR DISTRIBUTE THEM TO OTHERS.**

**Clipart and elements found in this PDF are copyrighted and cannot be extracted and used outside of this file without permission or license.**

**For more FREE materials follow us on:**

 <https://facebook.com/createdres>

 <https://t.me/freebooks4all>

 <https://twitter.com/createdres>

 <https://vk.com/createdres>

 <https://www.pinterest.com/createdres>

 <https://www.instagram.com/createdres>

***Thank you for your download!***

Name: ..... CVC Words







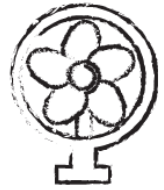



# Hidden Pictures

Directions : How many can you find ?

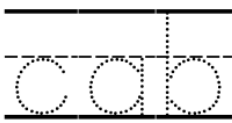

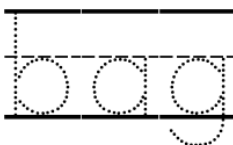
© Copyright English Created Resources 2021

				
How many do you see?				
Trace the word				

Name: ..... CVC Words



# Hidden Pictures

Directions : How many can you find ?



© Copyright English Created Resources 2021

How many do you see?				
Trace the word				

© Copyright English Created Resources 2021. All rights reserved.

Name: ..... CVC Words



# Hidden Pictures

Directions : How many can you find ?

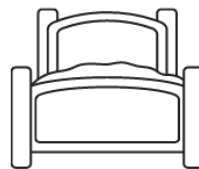
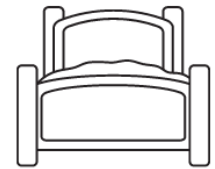
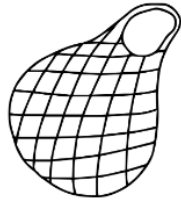
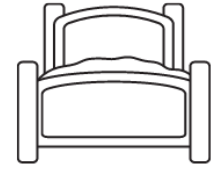
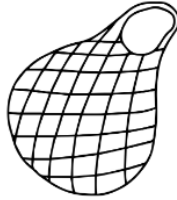
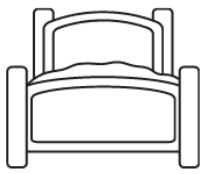

© Copyright English Created Resources 2021

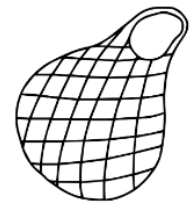

How many do you see?

Trace the word

bed

pen

leg

net

Name: ..... CVC Words







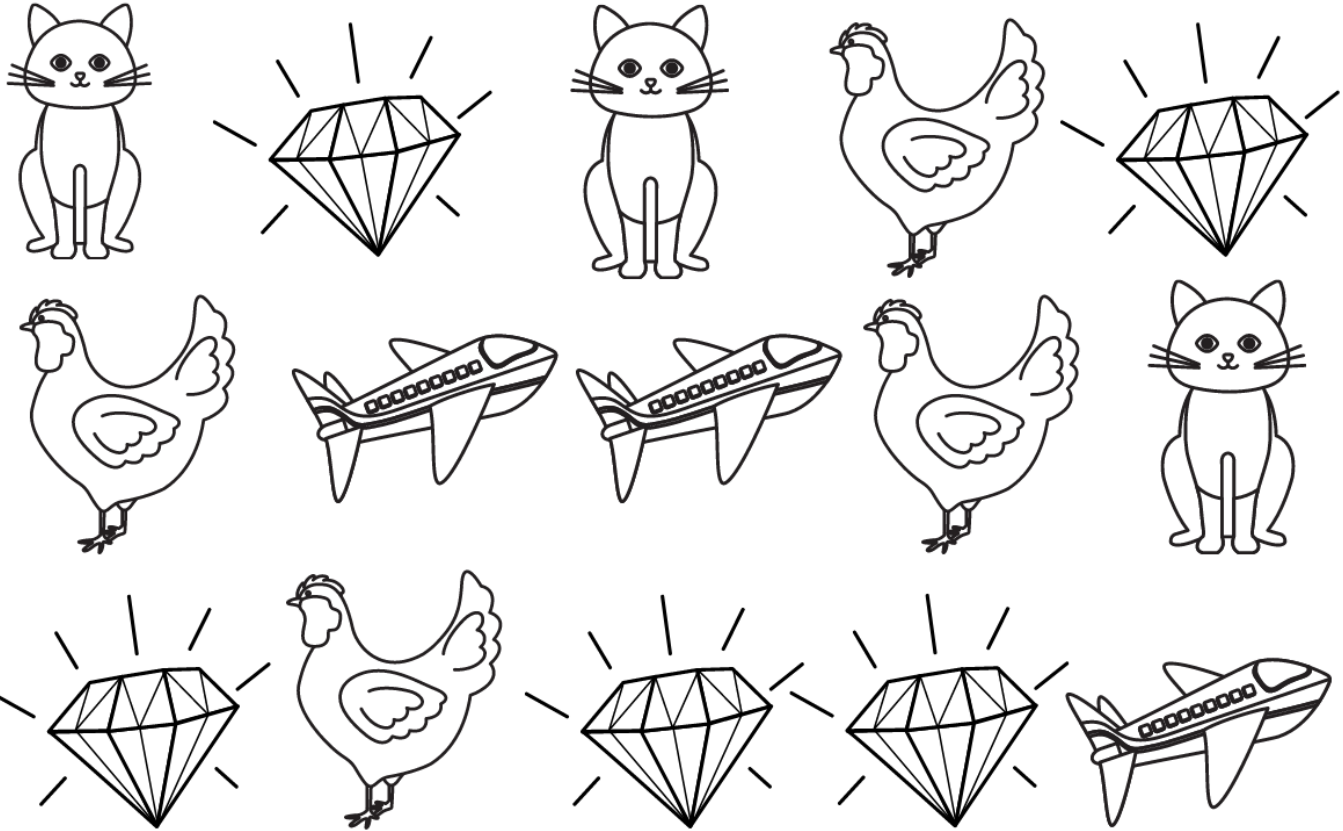

# Hidden Pictures

Directions : How many can you find ?

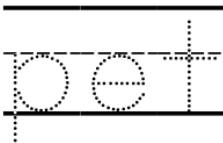

© Copyright English Created Resources 2021

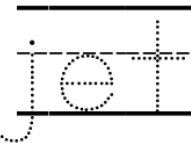
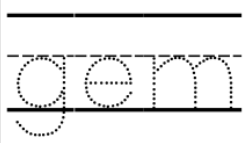
				
How many do you see?				
Trace the word				

Name: ..... CVC Words





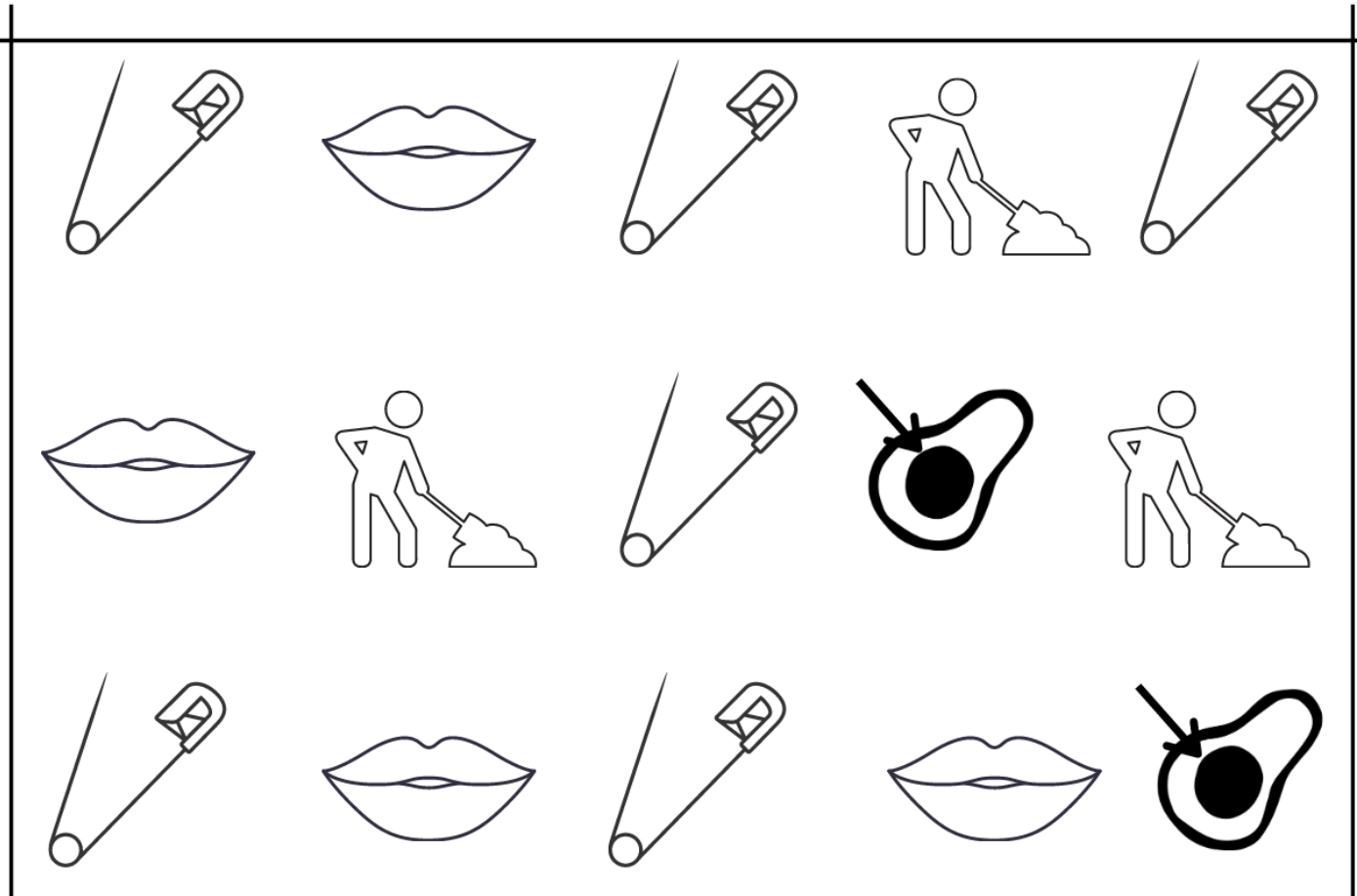

# Hidden Pictures

Directions : How many can you find ?

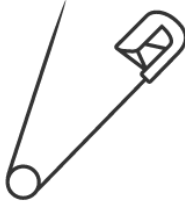

© Copyright English Created Resources 2021

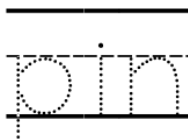
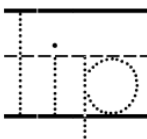
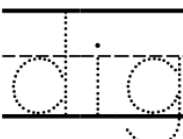
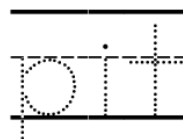
				
How many do you see?				
Trace the word				

Name: ..... CVC Words



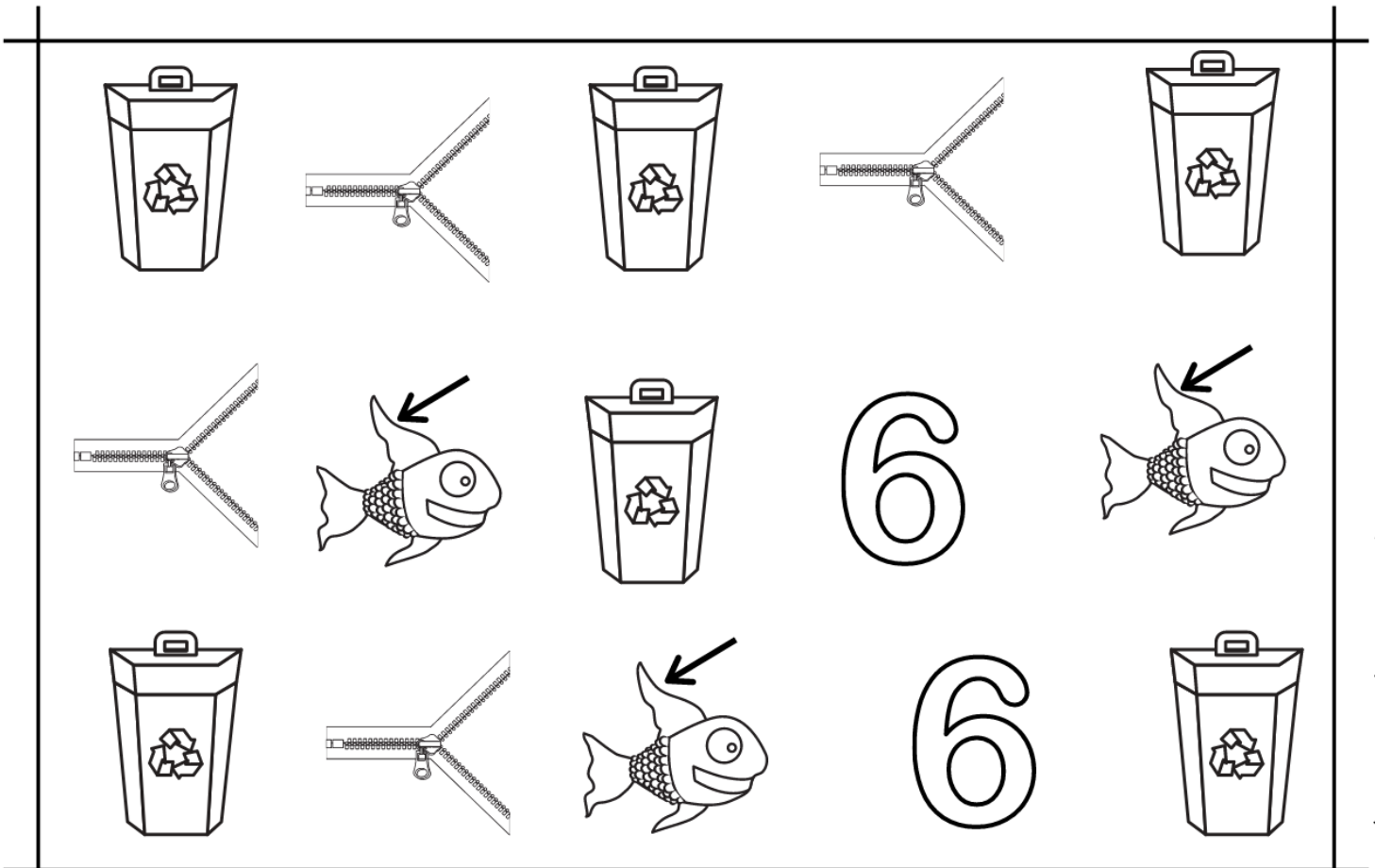

# Hidden Pictures

Directions : How many can you find ?

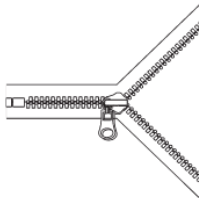
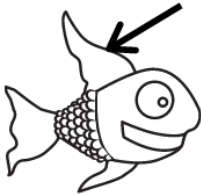
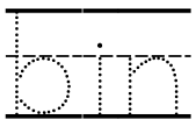
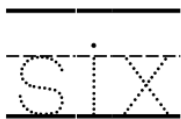
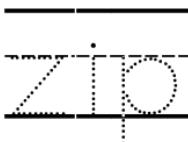
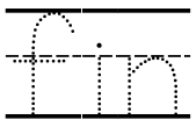

© Copyright English Created Resources 2021

				
How many do you see?				
Trace the word				

© Copyright English Created Resources 2021. All rights reserved.



Name: ..... CVC Words







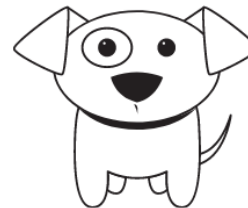
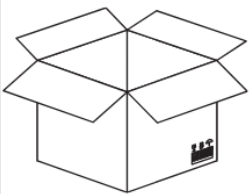
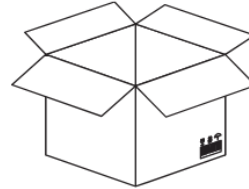
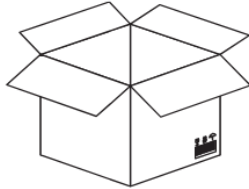

# Hidden Pictures

Directions : How many can you find ?

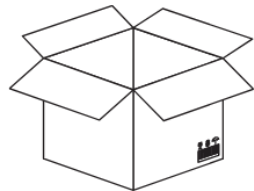

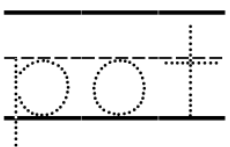
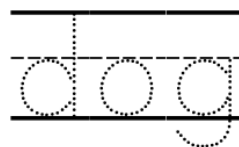
© Copyright English Created Resources 2021

				
How many do you see?				
Trace the word				

© Copyright English Created Resources 2021. All rights reserved.

Name: ..... CVC Words









# Hidden Pictures

Directions : How many can you find ?

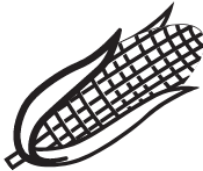

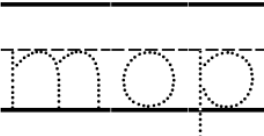
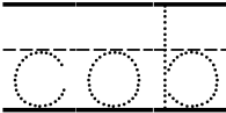
© Copyright English Created Resources 2021

				
How many do you see?				
Trace the word				

© Copyright English Created Resources 2021. All rights reserved.

Name: ..... CVC Words





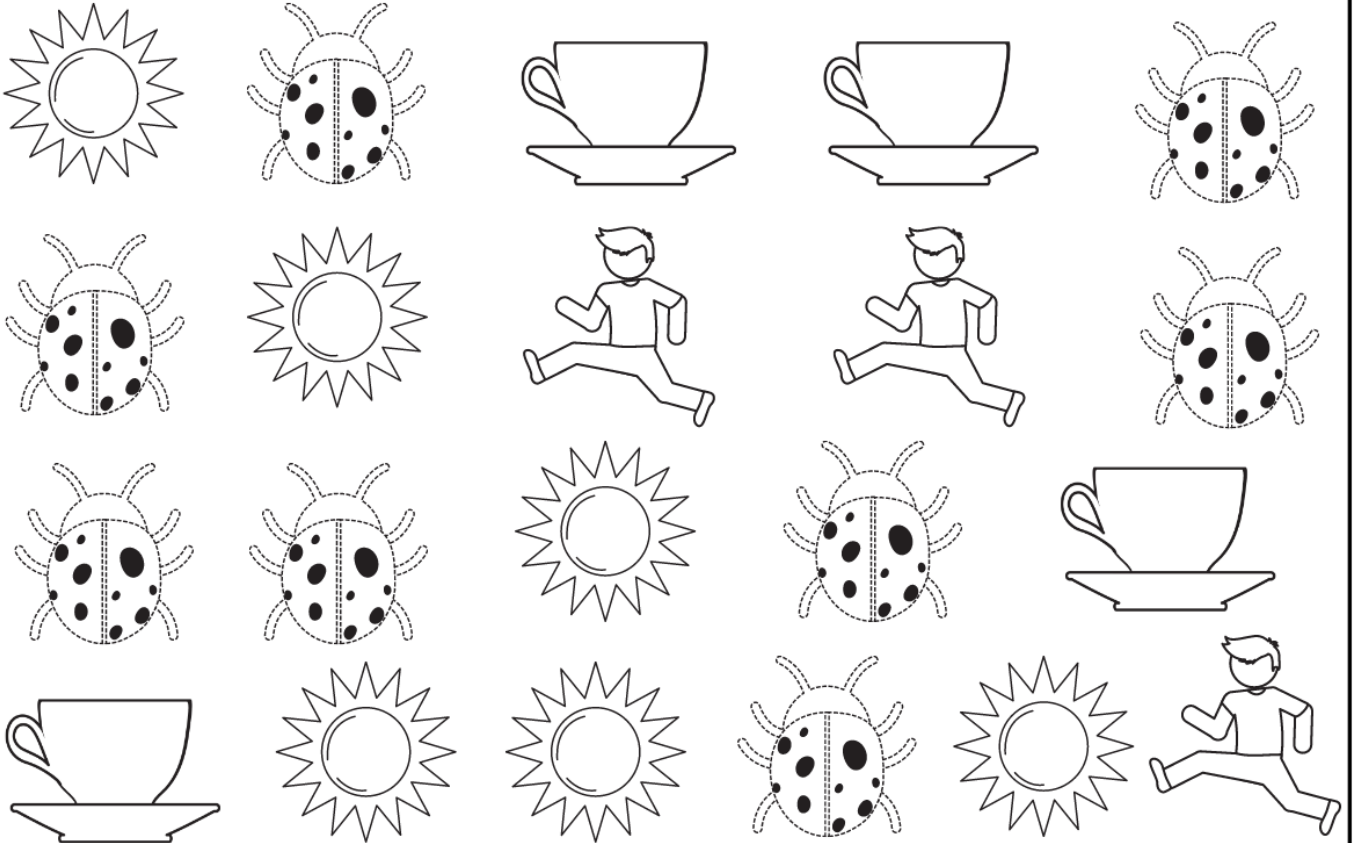

# Hidden Pictures

Directions : How many can you find ?



© Copyright English Created Resources 2021

				
How many do you see?				
Trace the word	sun	bug	cup	run

Name: ..... CVC Words





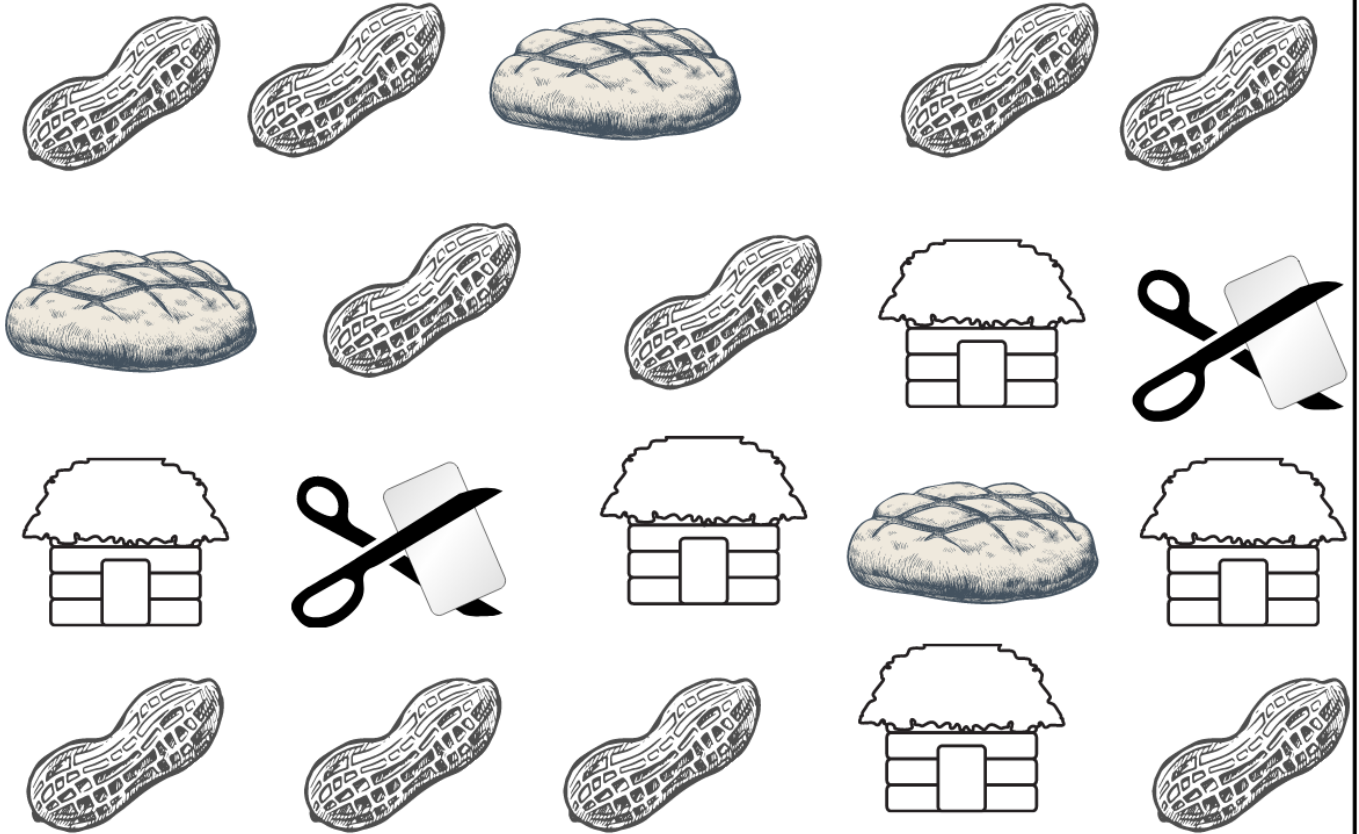

# Hidden Pictures

Directions : How many can you find ?

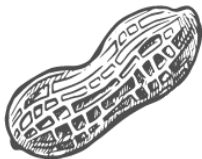
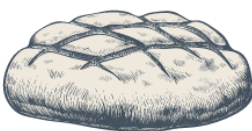

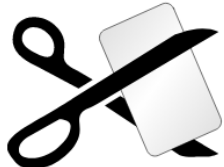
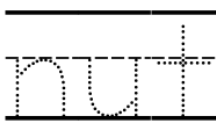
© Copyright English Created Resources 2021

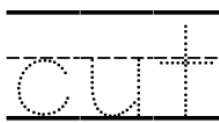
				
How many do you see?				
Trace the word				

© Copyright English Created Resources 2021. All rights reserved.



English Created Resources prides itself on providing everything a learner needs to improve the level of English.

Such materials are provided for free download to be available always for learners around the world. You can find English ESL worksheets for home learning, online practice, distance learning and for English classes.

Our Website helps you to give your child a boost using our free, printable worksheets. You will be able to help your child with his grammar skills with our printable worksheets that focus on using punctuation, reading and writing. Such Worksheets are a useful learning tool for kids who are trying to read, write or want to practice their English language skills at home.

## Designed by English Created Resources

 **Beni Suef, Egypt**

 **admin@createdres.com**

 [www.createdres.com](http://www.createdres.com)  
[www.eslworksheetpdf.com](http://www.eslworksheetpdf.com)  
[www.nortechplus.com](http://www.nortechplus.com)

**For more FREE materials follow us on:**

 <https://facebook.com/createdres>

 <https://twitter.com/createdres>

 <https://www.pinterest.com/createdres>

 <https://t.me/freebooks4all>

 <https://www.instagram.com/createdres>

 <https://vk.com/createdres>

